

3-HEAD
CASSETTE TAPE DECK

 PIONEER

CT-F850

HE, HB
D, D/G

OPERATING INSTRUCTIONS



The specifications of this model differ according to the shipment destination.

- For U.K. ('HB' stamped on packing case): Power line voltage is 240 volts. A 2-point (220V/240V) voltage selector switch is provided on the rear panel.
- For mainland Europe ('HE' stamped on packing case): Power line voltage is 220 volts. A 2-point (220V/240V) voltage selector switch is provided on the rear panel.
- For destinations excluding above ('D', 'D/G' stamped on packing case): A 3-point (120V/220V/240V) voltage selector switch is provided on the rear panel.

Before turning on the power, please confirm the setting of the line **VOLTAGE SELECTOR** plug on the rear panel. If it is not set properly, change the setting of it according to the **IMPORTANT LINE VOLTAGE** on page 16.

IMPORTANT

To prevent electric shock, do not remove cover. No user serviceable parts inside, refer servicing to qualified service personnel.

Always disconnect all the equipment from the mains supply when disconnecting the signal leads. The power cord should be connected last, make sure that the power switch is off.

Unplug the set from the wall socket when it is not to be used for an extended period of time.

FOR USE IN UNITED KINGDOM AND AUSTRALIA

CAUTION 240V: Mains supply voltage is factory adjusted at 240V.

FOR USE IN UNITED KINGDOM

The wires in this mains lead are coloured in accordance with the following code:

<i>Blue:</i>	<i>Neutral</i>
<i>Brown:</i>	<i>Live</i>

As the colours of the wires in the mains lead of this apparatus may not correspond with the coloured marking identifying the terminals in your plug proceed as follows.

The wire which is coloured blue must be connected to the terminal which is marked with the letter N or coloured black.

The wire which is coloured brown must be connected to the terminal which is marked with the letter L or coloured red.

CONTENTS

Features 2	Playback 11	Troubleshooting Insertion
Precautions 3	Operations with the Timer . . 12	Schematic Diagram . . . Insertion
Front Panel Facilities 4	Maintenance 12	Table of Leading Brands of Tapes Insertion
Connections 6	The Dolby NR System 13	
Basic Operations 7	Cassette Tapes 14	
Recording 8	Specifications 15	
Microphone Recording 10	Important-Line Voltage 16	

FEATURES

Transport Section Engineered for Stable Tape Run

This deck features the closed loop dual capstan system whereby a capstan is stationed on either side of the heads. This system maintains a stable contact between the heads and the tape so that the tape travels at a constant tension all the time, and it also helps to suppress dropouts in the tape and fluctuations in the level. Another important point is that external vibration transmitted from the reel bases and tape guides to the tape is kept down to the minimum for a marked reduction in the modulation noise and both recording and playback which are faithful to the original sound.

The DC servo motor which provides a stable rotational speed is combined with the ultra-precision-engineered capstans and good dynamic balance flywheels to yield a truly superior tape transport performance, and a great improvement in the wow and flutter characteristics.

Yet another prime feature is the mechanical governor motor with its powerful rotation torque and less ripple. This is used for the take-up operations, and enables reliable fast forward and rewind operations.

Three-Head System with Recording/Playback Combination Head

This deck adopts a recording head and a playback head which are combined to fit neatly into a single case as a tidy package. Each head is made of a sendust core and this makes it possible to exploit the features of both metal tapes, chrome tapes and ferrichrome tapes to the full. The heads are provided with a high level of resistance to wear and are tailored to produce tap-notch distortion characteristics with high input signal levels as well as an excellent frequency response and signal-to-noise ratio. The contact between the heads and the tape is surefire and firm and the adhering of dust and generation of noise caused by magnetization are reduced to the minimum. These are just a few of the amazing powers of the heads. What's more, the combination head can be used to monitor a recording virtually in real time if the playback head is put to work while you are recording.

Digital Bar Graph Display Level Meter

This deck's level meter features two bar graph fluorescent display tubes and it functions with all-electronic digital control.

The meter can naturally be used for ordinary VU display and an added convenience is that it can be used as a peak meter with a fast response time for detecting pulsing sound accurately. The level meter mode can be selected in accordance with the program source which you intend to record, and it facilitates the setting of the recording level corresponding to the contents of the actual programs.

Tape Selector and Bias Control to Do Full Justice to the Performance of Every Kind of Tape

The most is made of not only metal tapes but also chrome tapes, ferrichrome tapes and standard tapes with the tape selector which selects the equalizer and bias corresponding to the type of tape used and also with the bias control which allows the bias of the tape to be finely adjusted. Adjustments can therefore be made to suit the characteristics of each type of tape. The bias control can also be used to produce the frequency response of your preference.

Soft Push-type Tape Mode Selector Switches

Soft push-type electronic controls are adopted in the tape mode selector mechanism. The deck can be set to recording playback, forward, rewind, stop and pause directly just with a light push on the switch. There is also a full auto-stop mechanism which stops the tape when the tape is fully wound, and this safeguards the tape against damage.

Variety of Accessory Mechanisms

Dolby* noise reduction system:

A newly developed low-distortion IC is used for the Dolby NR system. This serves to reduce greatly the irritating noise heard when you play back a tape, and it does this without impairing the sound quality of the original program source. This helps to increase the dynamic range, and it allows recordings and play back with a good signal-to-noise ratio.

Output Level Controls with a Click-stop Position for Easy Pinpointing of the Reference Playback Level:

The output (playback level) controls can be used to vary the output level continuously and they are also coupled to the level meter. This means that it is possible to check the output level on the meter, regardless of the strength of the recording level. When the controls are set to their click-stop position, the reference playback level can also be checked.

Unattended recording, wake-up playback functions:

If you use the deck along with the optional timer, you can record the FM broadcasts you do not want to miss while you are out, and you can also wake yourself up in the morning with playback from a program source instead of being rudely awakened by an alarm clock buzzer.

Mic plug-coupled input selection:

When the program source is connected to the MIC jacks, the line input terminal signal is automatically switched to the microphone signal.

2 *Manufactured under license from Dolby Laboratories.
*Dolby and  are trademarks of Dolby Laboratories.

PRECAUTIONS

HANDLING THE POWER CORD

- Always take hold of the plug to unplug it from the power outlet; do not unplug it by pulling on the cord. The cord may be damaged if you keep pulling on it.
- Do not handle the power cord with wet hands. This is extremely dangerous because you may get an electric shock.

PRECAUTIONS FOR USE

- Under no circumstances should the bonnet be removed, and the internal parts touched or modified in any way. Pioneer will not be held responsible in the event of a deterioration in performance or a breakdown if the cassette deck is modified in any way.
- Do not bring screwdrivers and other metal objects or magnets near the heads since you may damage and magnetize them.

KEEP THE HEAD SECTION CLEAN

The heads, capstan and pinch roller get dirty very easily since they come in contact with the tape. For further details on cleaning the head section, refer to page 12 and the section on "MAINTENANCE."

Moisture forms in the operating sections of this model and the model's performance will be impaired if the model is brought from cool surroundings into a warm room or if the temperature of the room rises suddenly. To prevent impairing performance, let the model stand in its new surroundings for about an hour before switching it on, or ensure that the room temperature rises gradually.

INSTALLATION

To ensure the best sound quality and trouble-free operation, avoid setting up the tape deck in any of the locations described below.

Location liable to downgrade performance and result in breakdowns	Resulting trouble
1. Locations exposed to direct sunlight, or near heaters or other heat sources.	1. External heat causes the performance of the electronic parts to deteriorate, and operation becomes unstable.
2. Locations with poor ventilation, or with high humidity or moisture contents, or dusty locations.	2. Cause of faulty contact in input/output terminals, and rust. High humidity and a high moisture content cause deterioration in insulation. There is also the danger of current leakage and heat generation in the circuit parts. Dust or grease in the rotating parts causes the parts to deteriorate.
3. Locations susceptible to vibration.	3. These locations affect the precision parts adversely.
4. Locations where there are thinners, benzene and other types of volatile liquids, insect sprays or any kind of inflammable objects at hand.	4. These help to corrode the front panel. In particular, the heads are precision-finished to micron dimensions. Chemicals may reduce their performance, so exercise all due care.

FRONT PANEL FACILITIES

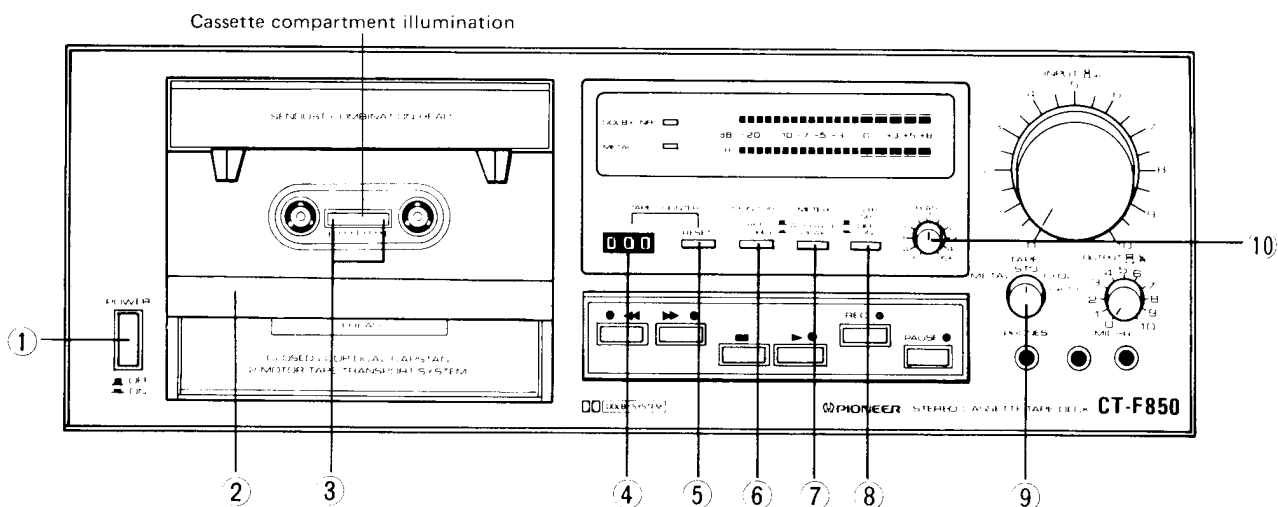

① POWER SWITCH

The power comes on when the POWER switch is depressed. The level meter and the cassette compartment illumination will then come on.

② DUST COVER

When you are not using the deck, always keep this cover in place to prevent dust and dirt from adhering to the head section and rotating parts.

③ REMAINING TAPE MARKER

If this marker is visible, it means that there is enough tape remaining for several minutes of recording or playback.

④ TAPE COUNTER

This indicates the position of the tape run.

⑤ TAPE COUNTER RESET BUTTON

Depress this button to reset the tape counter display to "000."

⑥ MONITOR SWITCH

This switch is used to select the output signals including those of the headphones. The level meter display is also selected simultaneously and so when adjusting the recording level, be sure to set this switch to SOURCE (depressed position).

For recording: If you depress this switch to SOURCE, you will be able to listen to the signals (recording input) just before they are recorded. If you then release to switch to TAPE, you will be able to hear the signals immediately after they have been recorded (playback sound).

Select this switch while you are recording (alternately between TAPE and SOURCE) and monitor the recording.

For playback: Release the switch to TAPE. You will not be able to listen to the playback sound if the switch is set to SOURCE.

⑦ METER SELECTOR SWITCH

PEAK: When this switch is depressed to PEAK, the meter functions as a peak meter.

AVERAGE: When the switch is released to AVERAGE, the meter functions as an ordinary level meter.

For further details, refer to "SETTING THE RECORDING LEVEL" on page 9.

⑧ DOLBY NR SWITCH

Set this switch to ON for recording with the built-in Dolby noise reduction system and for the playback of tapes which have been recorded using the Dolby NR system.

⑨ TAPE SELECTOR

This selector allows the bias and equalizer characteristics to be selected during recording and the equalizer characteristics during playback in line with the type of tape you are using. For details, refer to "SETTING THE TAPE SELECTOR" on page 9.

METAL: For using metal tapes

STD: For using ordinary or LH tapes

CrO : For using chrome tapes

Fe-Cr: For using ferrichrome tapes

⑩ BIAS CONTROL

Use this control to adjust the bias in accordance with the characteristics of the tape being used. It is set so that the center (click stop) position corresponds to the standard bias. For further details, refer to "ADJUSTING THE BIAS" on page 9.

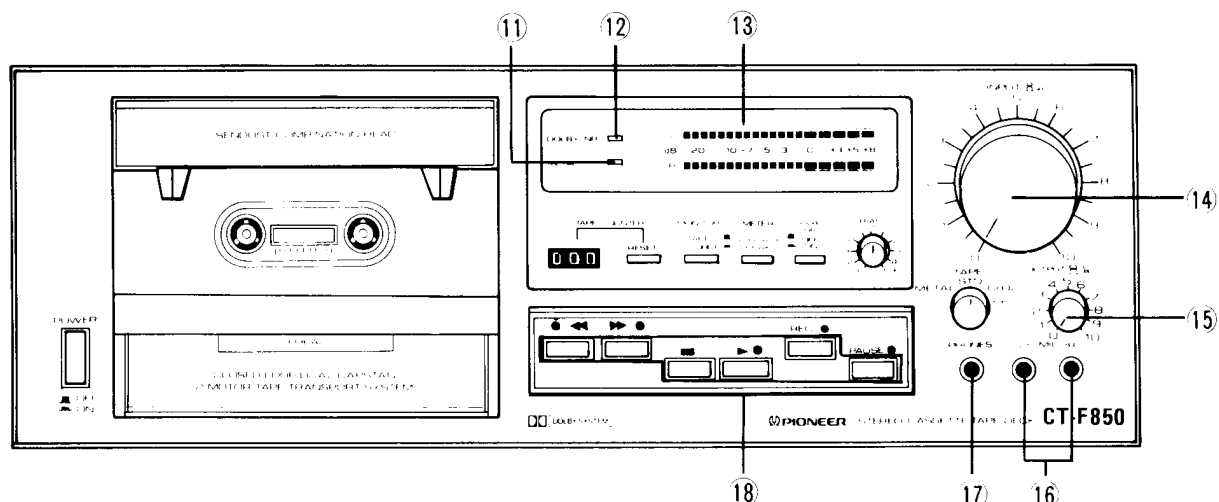

11 METAL TAPE INDICATOR

This light comes on when the TAPE selector is set to METAL.

12 DOLBY NR INDICATOR

This lights up when the DOLBY NR switch is set to ON and it indicates that a tape is being recorded or played back with the Dolby NR system.

13 LEVEL METERS

These indicate the input level during recording and the output level during playback.

By operating the METER selector switch, it can be made to function as a peak meter, or as a level meter.

The input signal level is indicated when the MONITOR switch has been depressed, and the playback output level is indicated when the MONITOR switch has been released.

14 INPUT (RECORDING LEVEL) CONTROLS

Use these to adjust the level of the input signals from the MIC jacks or rear panel INPUT.

Turning these controls to the right increases the level. For further details, refer to "SETTING THE RECORDING LEVEL" on page 9. The controls are coupled to the left and right channels, but you can also use them to adjust the right channel (back) and the left channel (front) independently.

15 OUTPUT (PLAYBACK LEVEL) CONTROLS

Use these to adjust the output signal level during playback. Turning the controls to the right increases the level. The controls are coupled when turned but it is also possible to adjust the right channel (back) and the left channel (front) independently.

When playing back a reference tape (160 nwb/m), a reference playback level (0dB) is obtained with these controls set to the "6" click stop position.

16 MIC JACKS

These are the input jacks for microphone recording. Plug the left channel microphone into the L jack and the right channel microphone into the R jack.

17 HEADPHONES JACK

This is the output jack for your stereo headphones. You will be able to hear sound from signals selected by the MONITOR switch. Use this jack when you want to monitor the quality of a recording or when you want to listen to a tape privately on the CT-F850.

NOTES:

- Use low-impedance headphones. If you use a high-impedance model, you will not be able to obtain sufficient volume.
- You will damage the microphone if you plug it into the PHONES jack by mistake.

18 OPERATING SWITCHES

- ◀ (REW): Depress this switch to rewind the tape at high speed. (The tape will travel from right to left.)
- ▶▶ (FF): Depress this switch to send the tape forward at high speed. (The tape will travel from left to right.)
- (STOP): Depress this switch to stop the tape run and to release the operating switches.
- ▶ (PLAY): Depress this switch when playing back a tape. (The tape will travel from left to right.)
- REC: Depress this switch together with the ▶ (PLAY) switch for recording. This switch will not work when a cassette is not loaded or when the erasure prevention tabs of a loaded cassette have been broken off.
- PAUSE: Depress this switch to stop the tape temporarily during recording or playback. Depress it again to allow the tape to continue to travel as before.

NOTES:

- When any of the operating switches are depressed, the corresponding indicator (except STOP mode) will come on signifying that the deck is set to that respective mode.
- The operating switches will not return to their original positions even when the power is switched OFF.

CONNECTIONS

Connect the CT-F850's terminals (OUTPUT—INPUT) to the tape terminals on the receiver (or stereo amplifier) with the accessory cords.

The upper terminal is for the left channel and the lower for the right channel.

Connections for playback: connect the TAPE PLAY input terminals on the receiver to the CT-F850's OUTPUT (PLAY) terminals.

Connections for recording: connect the receiver's TAPE REC output terminals to the CT-F850's INPUT (REC) terminals.

CT-F850 This rear panel is based on the D, D/G models

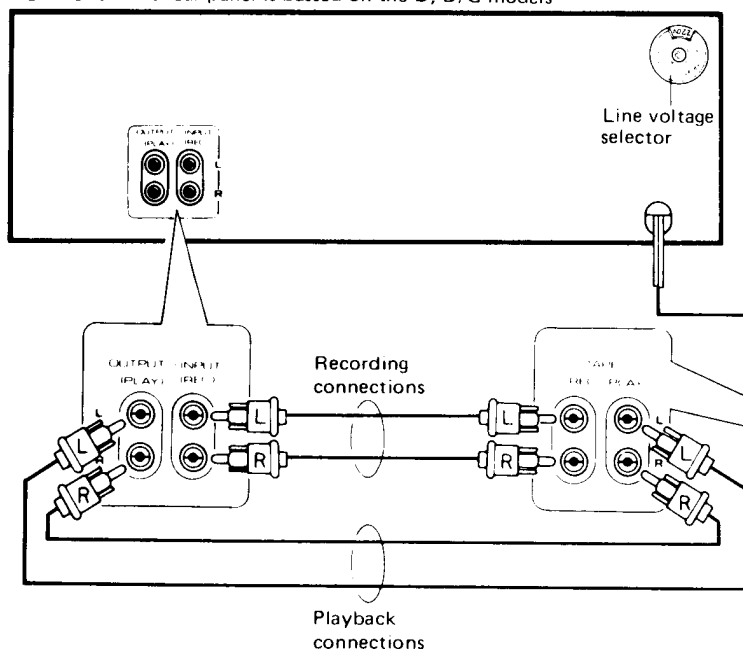

This rear panel for the HB, HE models

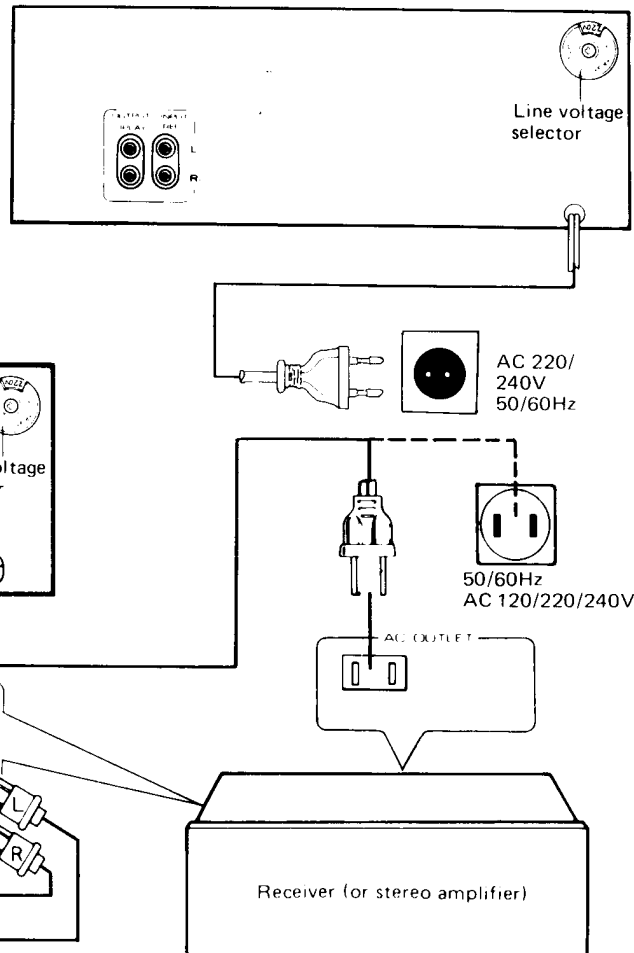

Tape slack take-up mechanism

The CT-F850 employs two capstans and so any slack in the tape will impair the effectiveness of their performance.

To safeguard against this kind of malfunction, the deck is provided with a tape slack take-up mechanism which eliminates any slack. What happens is that when the cassette tape is loaded, it sets the deck to take up the slack.

If, however, there is a great deal of slack, use a pencil or similar object to take it up before you load the cassette tape (refer to page 14).

BASIC OPERATIONS

TAPE INSERTION

Place your forefinger on the edge of the dust cover and pull towards you.

Aligning the cassette tape with the tape guide, push upward and insert. When you want to remove the tape, pull it towards you.

NOTE:

- Be sure not to take out cassette tape during tape running.

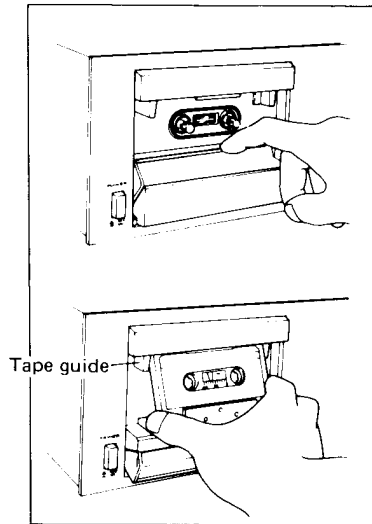

Rewind

1. Check that the tape is on the right reel.
2. The tape runs from right to left at high speed when the ◀ REW switch is depressed, and the tape is rewound.

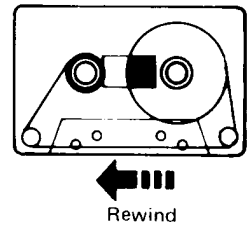

NOTES:

- You do not have to depress the ■ STOP switch when selecting the next mode with the CT-F850.
- Do not depress more than one switch at a time except when recording and for PAUSE mode.

STOP OPERATION

Stopping the tape

Depress the ■ STOP switch to stop the tape travel. This switch does not lock when depressed.

Using the Pause Switch

1. The tape will stop when the PAUSE switch is depressed while the tape is traveling (recording or playback).
2. When the PAUSE switch is depressed back to the original position, the tape will start traveling again (recording or playback).

NOTES:

1. When stopping the tape for a prolonged period of time, use the ■ STOP switch.
2. When using a pre-recorded tape to re-record a program, bear in mind that the pre-recorded sound will sometimes not be erased at the place on the tape where you set the deck to the PAUSE mode.

The PAUSE switch comes in handy in the following instances:

- When the recording level is set.
- When you want to edit out some portions of a program during recording and then continue recording.

TAPE RUN

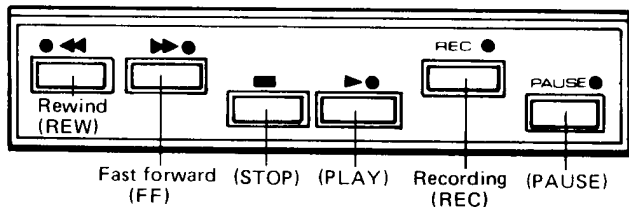

Play and record

1. Check that the tape is on the left reel.
2. The tape runs from left to right when the ▶ PLAY switch is depressed. If the REC switch is also depressed together with the ▶ PLAY switch, the deck will be set to the recording mode.

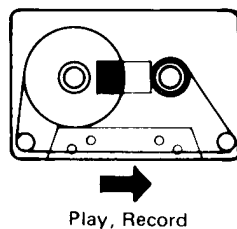

Fast forward

1. Check that the tape is on the left reel.
2. The tape runs from left to right at high speed when the ►► FF switch is depressed for a fast forward operation.

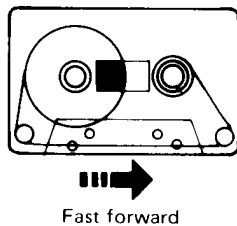

AUTO-STOP MECHANISM

When the tape is fully rewound onto one of the reels during recording, playback, fast forward or rewind, the auto-stop mechanism is activated without the ■ STOP switch having to be depressed, and the tape will automatically come to a halt several seconds later.

The power does not go off when the auto-stop mechanism is activated. When switching off the power, always depress the ■ STOP switch first.

RECORDING

Follow the recording procedure below in numerical order. The step numbers are illustrated in the figure.

Set the switches and controls as follows before you switch the power on.

- Set the METER switch to AVERAGE.
- Set the INPUT controls to the leftmost position.
- Inspect the head section for dirt. If dirty, clean it. (Refer to page 12.)
- Set the OUTPUT controls to the "6" click position.
- Set up the program source (records, FM broadcast, microphone performance, etc.) which you intend to record.

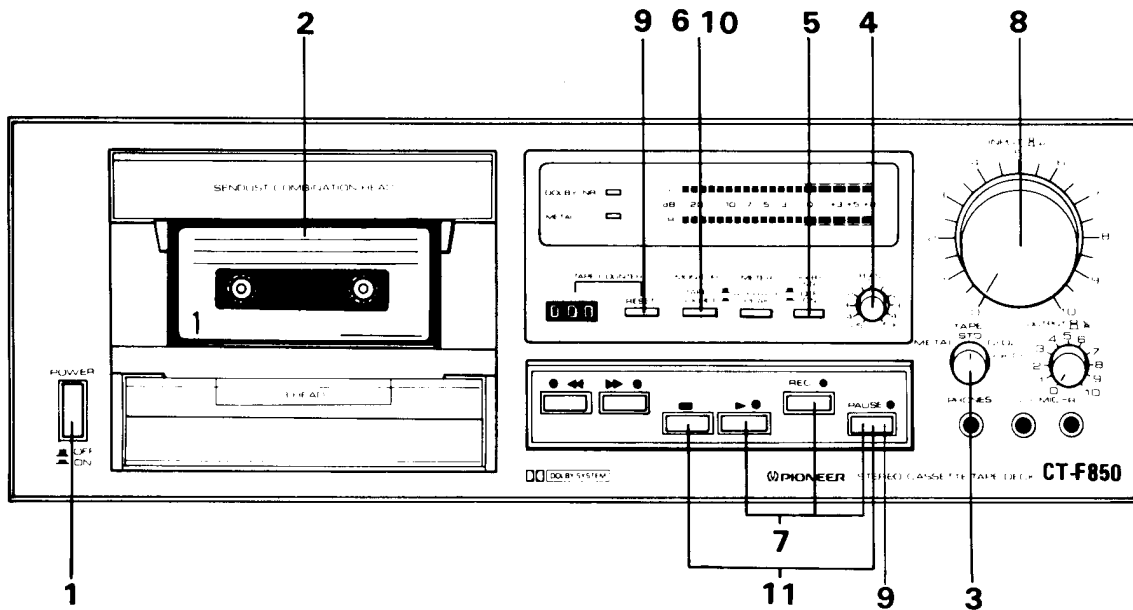

1. Set the POWER switch to ON.

2. Insert the cassette tape.

Check that the tape is on the left reel. Also check that the cassette tape's erasure prevention tabs (refer to page 14) have not been broken off and then insert (refer to page 7).

3. Select the TAPE selector position.

If you have loaded a metal tape into the deck, set this selector to METAL. Set to Fe-Cr for a ferrichrome tape, to STD for a standard tape and to CrO₂ for a chrome tape. For details, refer to the table which is inserted into the operating instructions.

4. Set the BIAS control.

Set the BIAS control to the center (click stop) position or to the setting that corresponds to the tape which you are using. For details, refer to "SETTING THE TAPE SELECTOR" on page 9.

5. Set the DOLBY NR switch.

Set this switch to ON if you intend to use the Dolby NR system (Refer to page 13).

6. Depress the MONITOR switch to the SOURCE position.

7. Stand by for recording.

Depress the PAUSE switch first, and then the PLAY▶ and REC switches together. Depress the PAUSE switch, allow the tape to run for about 5 seconds and then

depress the PAUSE switch again if you want the leader tape to run free of the heads or if you want to record a blank (no signals) between programs.

8. Set the recording level.

Refer to "Setting the recording level" on page 9 and then set the INPUT controls.

9. Start recording.

First depress the COUNTER RESET button and set the tape counter to "000."

Then release the PAUSE switch, start the performance of the program source, and start recording.

10. Monitoring the recording.

You can monitor the recording level on the level meter or, depress the MONITOR switch and you will then be able to listen and compare the sound quality with that when the MONITOR switch was released. If there is anything wrong with the sound when the MONITOR switch is released, it may be due to a deformed tape, dirt in the head section or the recording level or BIAS control and TAPE selector may be set incorrectly. Locate the fault and start recording again.

11. Complete recording.

When the recording is completed, depress the STOP ■ switch and stop the tape. Depress the PAUSE switch to stop the tape temporarily. The auto-stop mechanism will be automatically actuated when the tape is fully sound onto the right reel during recording.

FOLLOW-ON RECORDING

You can record a new program source onto a pre-recorded tape which is playing in the deck if you depress the ► (PLAY) and REC switches together. This procedure is particularly effective for tape editing.

LEVEL METER

The peak meter can cope more sensitively with sudden peak inputs than the level meter can. The level meter serves almost to simulate your sense of hearing, and it indicates the average strength of the input signals. Naturally, the peak input signal which is recorded has a higher level than the average level and so the standard '0dB' level meter level is set lower than the saturation level of the tape. The peak meter is constructed so that its very fast response speed indicates peaks even if pulse-like signals are included in the input signals. When performing live recordings or when recording sources with a great many peak portions, make use of the peak meter and you will then ensure that the sound will not be distorted at the peak level.

USING THE MONITOR SWITCH

This deck is a 3-head model with independent erase, recording and playback heads. If you set the MONITOR switch to TAPE during recording, you will be able to listen to the program you have just recorded. If you then set it to SOURCE, you will be able to listen to the sound you are about to record. By switching back and forth between the two positions, therefore, it is possible to check the quality of the recording on your headphones. When monitoring the recording on a stereo amplifier connected to the deck, set the tape monitor switch on the stereo amplifier to the ON position.

ERASING RECORDED SOUND

- To completely erase a program which you have already recorded, turn the recording level (INPUT) controls to their leftmost position, and run the tape with the deck set to the recording mode.
- When recording a new program over a pre-recorded tape, the previous sound will be automatically erased and the new program will be recorded over it.

MICROPHONE RECORDING

STEREO RECORDING

As shown in Figure use a stereo microphone or two identical microphones and connect the one for the left channel to the MIC L jack and the one for the right channel to the MIC R jack. For the actual recording, refer to "Recording" on page 8.

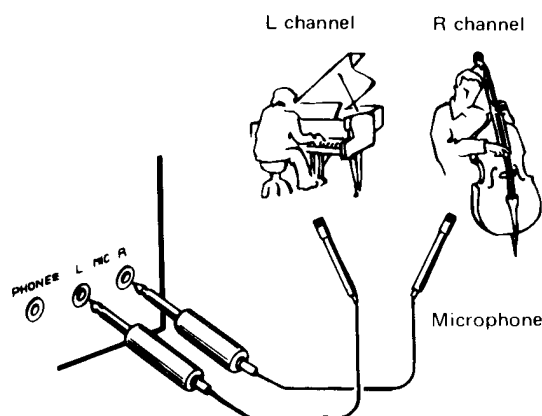

Points to bear in mind

- Use dynamic or electret microphones.
- When microphones are plugged into the MIC jacks, the signals from the microphones take priority even if the input signals are being supplied to the INPUT terminals. When recording from the INPUT terminals, always disconnect the microphones.
- You may damage the microphone if you plug it into the PHONES jack by mistake.
- Monitoring the recording with the speakers very often gives rise to howl so use the microphones as far away as possible from the speakers. There will be no howl, however, with headphones.

PLAYBACK

Follow the playback procedure below in numerical order. The step numbers are illustrated in the figure.

Set the switches and controls as follows before you switch the power on.

- Depress the COUNTER RESET switch to reset the tape counter display to "000".
- Set the METER switch to AVERAGE.
- Set the MONITOR switch to TAPE.
- Set the OUTPUT controls to the "6" click position.
- Check that the head section is not dirty. If dirty, clean it.
- Set the stereo receiver's power switch and the TAPE MONITOR switch to ON to enable tape playback.

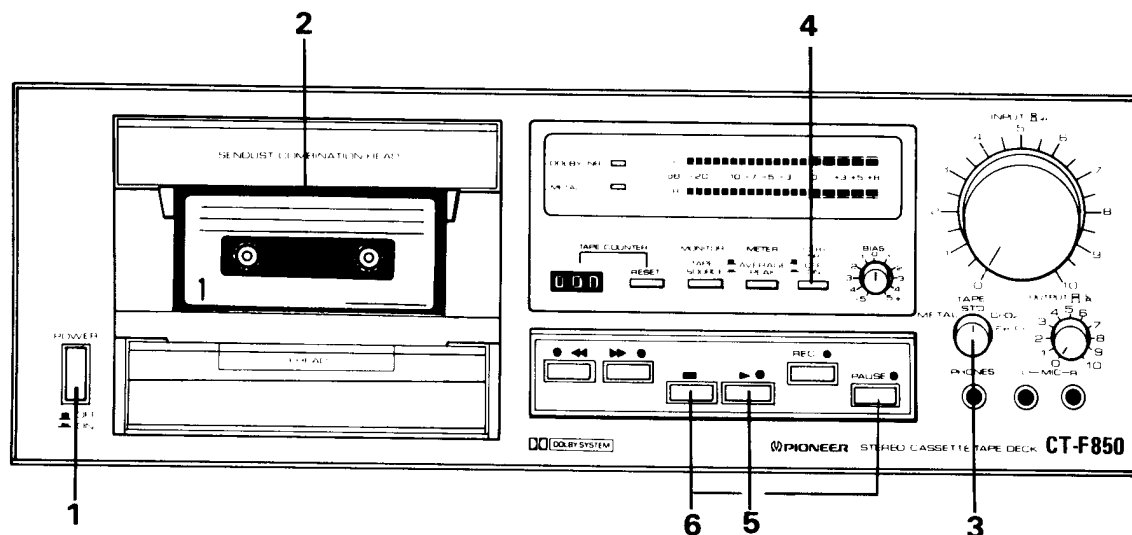

1. Set the POWER switch to ON.

2. Insert a cassette tape.

Check that the tape is on the left reel and then insert (Refer to page 7).

3. Select the TAPE selector position.

If you have loaded a metal tape into the deck, set this selector to METAL. Set to Fe-Cr for a ferrichrome tape, to STD for a standard tape and to CrO₂ for a chrome tape. For details, refer to the table which is inserted into the operating instructions.

4. Set the DOLBY NR switch.

Set this switch to ON when playing back a tape which was recorded by Dolby NR system. For further details on the Dolby NR system, refer to page 13.

5. Start playback.

Depress the ► (PLAY) switch and the tape will start to run. Adjust the volume to the preferred level by rotating the volume control on the stereo receiver.

6. Complete playback.

The tape will stop when it has been wound onto the right reel.

Depress the ■ (STOP) switch when you want to stop the tape run during playback. Depress the PAUSE switch for a temporary stop.

OUTPUT LEVEL CONTROLS

These controls are used to adjust the output signal level when a tape is being played back, and also the volume level of the headphones. Turning the controls to the right increases the level. When the front L (left) channel control is turned, the R (right) control is coupled and it moves along with the L control. The R control at the rear can be adjusted separately by rotating it independently. If the volume of the left and right channels is to be changed, use the L channel as the reference and then rotate the R channel control.

Since these controls are coupled to the level meter, it is possible to adjust the indication of the meter

so that it corresponds with the recording level—whether high or low—when the pre-recorded tape is played back.

When the L channel control is set to its click-stop position and a tape is played back, the reference playback level is indicated by a meter display of 0dB. In this case, make absolutely sure that the index line on the R channel control is aligned with that of the L channel control. This function allows you to check the difference in sensitivity between your various tapes and also to check the signal level especially when playing back or recording a tape with the Dolby NR switch at ON.

OPERATIONS WITH THE TIMER

UNATTENDED RECORDING

If you use an optional timer, you will be able to automatically record an FM broadcast or other program source at a specified time. This is convenient for recording programs when you are out or asleep.

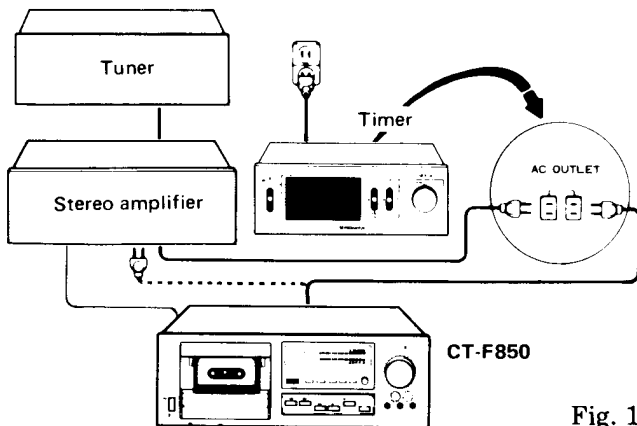

Fig. 1

1. As shown in Fig. 1 connect the CT-F850's power cord to the timer. At the same time connect the power cord of the stereo component (receiver, tuner, or amplifier, etc.) which is connected to the CT-F850 so that the power ON/OFF functions of that component are controlled by the timer.
 2. Set the power switches of the CT-F850 and stereo component to ON, and select the broadcasting station whose program you want to record.
 3. Set the recording level by following the procedure under "Recording" steps 1 to 8 on page 8. Depress the PAUSE switch and then depress the REC and ► PLAY switches together to set the deck to the recording stand-by mode.
 4. Set the timer so that the power will come on at the prescribed time. The power to the other stereo components goes off.
 5. Release the PAUSE switch.
 6. The power will automatically be switched on at the timer's preset time, and recording will start about four seconds later. Once the tape has been fully rewound, the auto-stop mechanism will be activated and the tape will stop. The timer will now operate to switch off the power to the deck and the stereo system.
- Turn the receiver's volume control left down so that the sound is not heard through the speakers while you are out.
 - For more details on the connections, refer to the

timer's instructions booklet.

- Set the time on the timer so that the power to the CT-F850 and stereo component goes off after the tape is fully wound onto the right reel.

WAKE-UP PLAYBACK

You can have the CT-F850's play back a pre-recorded tape automatically at a desired time. You can set the timer so that the tape's music wakes you up instead of an alarm clock.

1. Connect the deck as in Fig. 1, and set the controls following the procedure under "Playback" steps 1 to 5 on page 11.
2. Set the timer so that the power will come on at the desired time.
3. The power will then come on at the preset time and playback will start about four seconds later.

MAINTENANCE

Follow the maintenance instructions below to keep your deck working in tip-top condition.

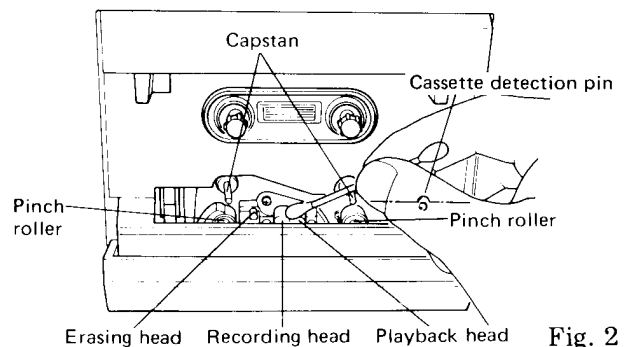

Fig. 2

CLEANING THE HEAD SECTION

Fig. 2 shows that the head section is composed of the heads, capstan and pinch rollers, and with extended use these parts accumulate dust, dirt and grease easily as the tape runs.

If this assembly gets dirty, the contact between the tape and the surface of the heads is impaired and this downgrades the sound quality and stereo balance, and it also leads to unstable operation. To prevent this, clean the head section and the surrounding parts regularly with the accessory cleaning swabs or with a soft cloth dipped in the cleaning fluid.

You will find that it is easier to clean the pinch roller if you depress the cassette detection pin and the PLAY switch. After the cleaning, depress the STOP switch to bring the mechanism to a stop.

NOTE:

When the cassette detection pin is depressed, the tape slack take-up mechanism will be actuated. This does not indicate a failure so continue to clean the pinch roller.

DEMAGNETIZING THE HEADS

The recording head becomes magnetized when you use the tape deck for prolonged periods of time. This results in noise being generated and the treble dropping off during recording and playback. The recording head should therefore be regularly demagnetized with the head eraser, which is sold separately. For further details, refer to the head eraser's instructions booklet.

CLEANING THE FRONT PANEL, DUST COVER

Use a soft cloth to wipe off dust and grease from the front panel and dust cover. When these parts are very dirty, dip the soft cloth in a small amount of neutral cleanser, remove the dirt and wipe dry with a dry cloth. Never use volatile sprits like thinners, benzine or alcohol because they will damage the panel's finish.

THE DOLBY NR SYSTEM

A cassette tape travels at one quarter of the speed of an open-reel (19cm/sec, 4-track) tape, and its track width is only 60 percent in comparison. The cassette tape is thus clearly at a disadvantage with respect to the signal-to-noise ratio.

The Dolby NR system is designed to reduce the noise called hiss which is inherent in tapes, and it is effective in upgrading the signal-to-noise ratio. It is so effective, in fact, that it is now indispensable to cassette decks.

The basic principle of the Dolby NR system is as follows: when signals with a relatively low level are recorded, the Dolby circuitry enhances the signals in the high-frequency range which has most of the hiss components, and these signals are then recorded. When they are played back, the circuitry attenuates only those components which were enhanced during recording. This returns the signal components to the normal level, and the hiss is reduced (by a maximum of 10dB) during playback

only for that level which was attenuated. In the same way, if the Dolby NR system is used for recording, the recording level can be set relatively low which enables almost distortion-free good sound quality tape recordings.

Operating precautions

- The adjustment of the recording level is basically the same as when the Dolby NR system is not used.
- In order to make the most of the effect of the Dolby NR system, choose a program source with as little noise as possible.
- If you have used the Dolby NR system to record a program, make sure that you use it when playing the same program back.
- Playing back a normally recorded tape with the Dolby NR system and playing back normally a tape which was recorded by the Dolby NR system will result in an unnatural reproduction of the sound on the tape.

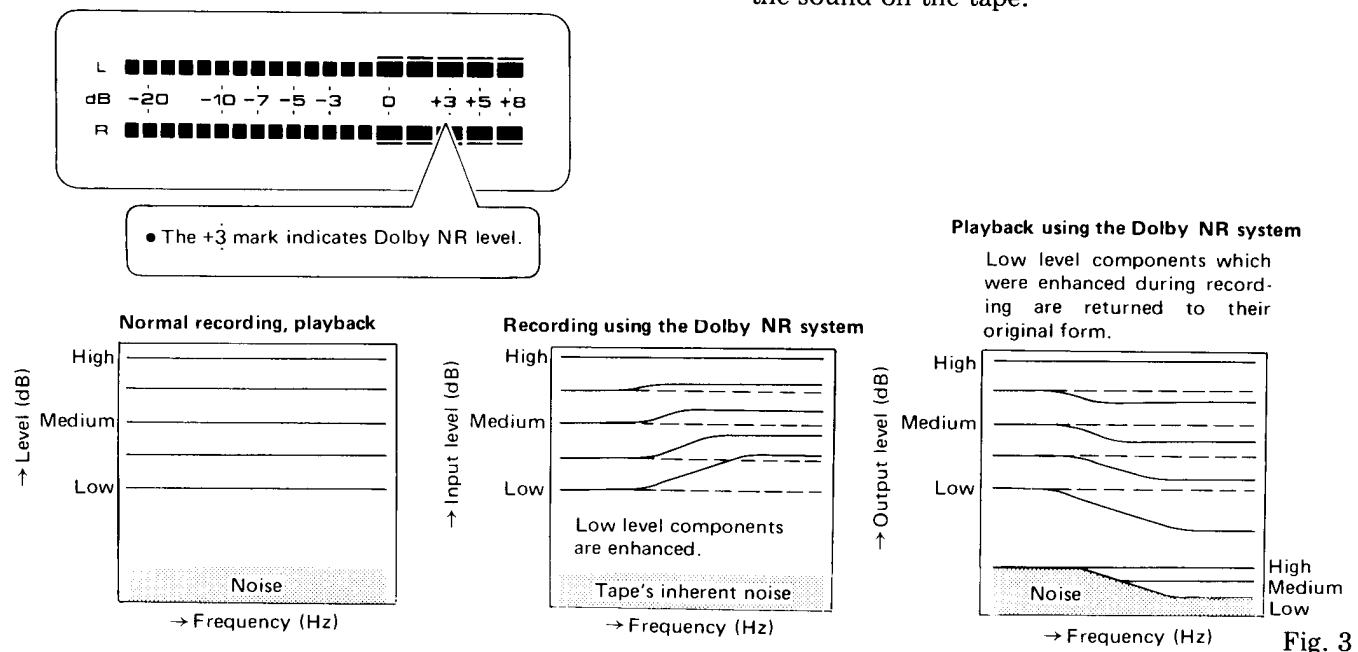

Fig. 3

CASSETTE TAPES

Cassette tapes are manufactured according to international standards governing their construction, and they are generally classified according to their tape performance and recording time.

Performance classifications

Standard type	Low-noise type	High-performance type
<ul style="list-style-type: none"> • Standard tape • Dynamic tape 	<ul style="list-style-type: none"> • Low-noise tape • Low-noise, high-output tape 	<ul style="list-style-type: none"> • Chrome tape • Ferrichrome tape • Metal tape

Recording time classifications

Cassette tape designation	Recording time (minutes)	
	One side	Both sides
C-30	15	30
C-46	23	46
C-60	30	60
C-90	45	90
C-120	60	120

The size of the cassette tapes is the same but their playing (and recording) times differ according to the tape thickness (length).

The C-60 and C-90 tapes are most commonly used. The C-120 tapes are not recommended because their mechanical and electrical specifications vary.

CHECK CASSETTE BEFORE USE

Slack or protruding tapes

If the tape protrudes from the cassette as shown in Fig. 4 or is slack, the tape may run without passing through between the capstan and the pinch roller and so may be damaged. Take up the slack by inserting a pencil through the reel hub and turning it as indicated in the figure 4 .

Some tapes provide a tape stopper to prevent tape slack. Make sure that you remove the tape stopper before inserting the tape into the deck.

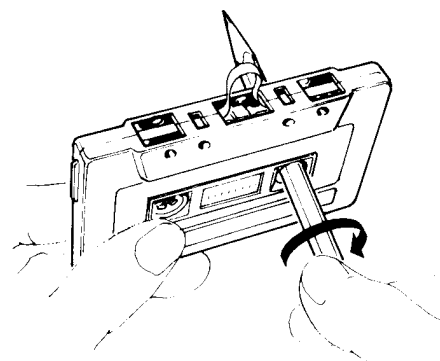

Fig. 4

Erasure prevention tabs

Cassette tapes are provided with erasure prevention tabs, as shown in Fig. 5, which act as a protection device to prevent the accidental erasure of a recording which you want to keep. If you remove the tabs, as shown in Fig. 5, with a screwdriver you will be able to prevent erasure if you accidentally set the CT-F850 to the recording mode by depressing the REC switch.

To re-record, cover the tab opening with a double layer of adhesive tape (Fig. 6).

NOTE:

Cassette tapes are provided with two tabs (A or 1 and B or 2) so you can protect the recordings on both sides.

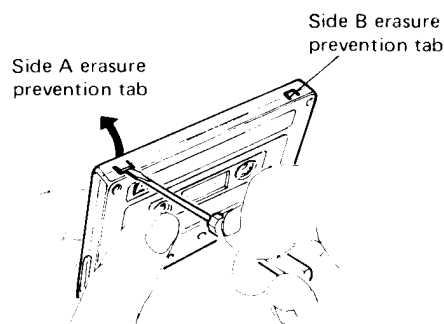

Fig. 5

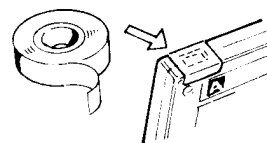

Fig. 6

SPECIFICATIONS

Systems Compact cassette, 2-channel stereo
 Motors Capstan drive; DC servo motor x 1
 Reel drive; DC high torque motor x 1
 Heads Sendust recording/
 playback combination type head x 1
 Erasing head x 1
 Fast Winding Time Approximately 85 seconds
 (C-60 tape)
 Wow and Flutter No more than 0.04% (WRMS)
 No more than ±0.14% (DIN)

Frequency Response
 -20dB Recording
 Standard, LH tapes 20 to 17,000Hz
 (25 to 15,000Hz ± 3dB)
 Ferrichrome tape 20 to 18,000Hz
 (25 to 17,000Hz ± 3dB)
 Chromium dioxide tape 20 to 18,000Hz
 (25 to 17,000Hz ± 3dB)
 Metal tape 20 to 19,000Hz
 (25 to 18,000Hz ± 3dB)
 0dB Recording
 Chromium dioxide tape 20 to 11,000Hz
 Metal tape 20 to 14,000Hz
 Signal-to-Noise Ratio Dolby NR OFF; More than 59dB
 Dolby NR ON; More than 69dB
 (over 5kHz)

Harmonic Distortion No more than 1.2% (0dB)
 Inputs (Sensitivity/Maximum allowable input/Impedance)
 MIC (L, R); 0.3mV/100mV/10 kilohms, 6mm diam. jack (Refer-
 ence MIC impedance; 250 ohms to 10 kilohms)
 LINE x 2; (64mV/25V/85 kilohms) Pin jack
 Outputs (Reference level/Maximum level/Load impedance)
 LINE x 2; (450mV/630mV/50 kilohms) Pin jack
 HEADPHONES x 1; 70mV/98mV/8 ohms, 6mm diam. jack

Semiconductors
 Amplifier Section Transistors x 49, ICs x 10,
 Diodes x 51 (including Zener Diodes x 3, LEDs x 7)
 Motor control Section Transistors x 3, Diode x 1

Subfunctions
 • Dolby NR system (ON-OFF) with LED indicator lamp
 • Fluorescence tube level meter (-20 to +8dB)
 (Peak/Average selector)
 • Bias fine adjusting control knob
 • 4 position tape selector (STD/METAL/CrO₂/Fe-Cr)
 • Automatic tape slack canceller
 • Cassette compartment illumination
 • Standby mechanism with unattended recording
 • Output level controls with click stop for reference playback level
 Power Requirements AC 120V, 220V, 240V (switchable)
 50/60Hz (D, D/G models)
 or AC 220V, 240V (switchable) 50/60Hz (HE, HB models)
 Power Consumption 45 watts (D, D/G models)
 50 watts (HE, HB models)

Dimensions
 D, HE, HB, model only; 420(W) x 150(H) x 361(D)mm Max.
 16-9/16 x 5-15/16 x 14-1/4 in.
 D/G model only; 452(W) x 160(H) x 361(D)mm Max.
 17-13/16 x 6-5/16 x 14-1/4 in.
 Weight HE, HB models only; 9.5kg (20lb 14oz)
 D model only; 9.3kg (20lb 7oz)
 D/G model only; 9.9kg (21lb 12oz)

Furnished parts Stereo connecting cords with pin plugs x 2
 Fuse (D, D/G model only) x 1
 (1.5A or 800mA)
 Head cleaning swabs x 3
 Operating instructions x 1
 Operating instructions (HE model only) x 2

NOTE:
 Specifications and the design subject to possible modification
 without notice due to improvements.

- NOTES:
- Reference Tapes: Standard & LH: DIN 45513/BLATT6 or equiv.
 : CrO₂: DIN 45513/BLATT7(CrO₂) or equiv.
 - Reference Recording Level: Meter 0dB indicating level (160 nwb/m magnetic level = Philips cassette reference level)
 - Reference Signal: 333Hz
 - Wow & Flutter: ● JIS [3kHz, with acoustic compensation (weighted), rms value]
 - Frequency Response: ● Measured at -20dB level, DOLBY NR OFF, level deviation is ±6dB without indication.
 - Signal to Noise Ratio: ● Measured at the third harmonic distortion 3% level, weighted.
 - Sensitivity: Input level (mV) required for reference recording level with input (REC) controls set to maximum.
 - Maximum Allowable Input: While decreasing settings of input (REC) level controls and increasing level at input jacks, this is the maximum input level (mV) at the point where recording amplifier output waveform becomes clipped.
 - Reference Output Level: Playback output level when meter indicates 0dB.
 - Maximum Output Level: Playback output level with respect to reference recording level when output (PLAY) level controls are set to maximum.

Dimensions
 D, HE, HB models only

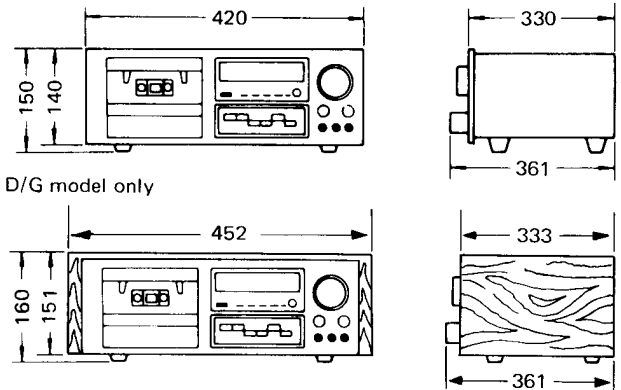

Unit: mm

IMPORTANT-LINE VOLTAGE

CT-F850 are designed to accept different line voltages, according to the country in which they are to be used, although the operation of the various models is the same in every respect. Fig. 7 shows the model designed to operate at any of two pre-selected voltages (220V, 240V).

Fig. 8 shows the model designed to operate at any of three selected voltages (120V, 220V, 240V).

Line voltage and fuse can be changed and set as follows:

220V and 240V MODEL

1. Disconnect the power cord.
2. Loosen the screw on the selector plug with a Phillips screwdriver, then take out the plug.
3. Re-install the plug with its cutaway section exposing the correct voltage indication as illustrated (Fig. 7).
4. Tighten the mounting screw.

120V, 220V and 240V MODEL

1. Disconnect the power cord.
2. Use a Phillips screwdriver to take out the fuse cap and fuse (Fig. 8).
3. Pull out the selector plug from the socket.
4. Put the selector plug back so that the appropriate line voltage marking can be seen through the cut in the edge of the plug.
5. Change the fuse in accordance with the table.
6. Replace the fuse and fuse cap.

220V, 240V model

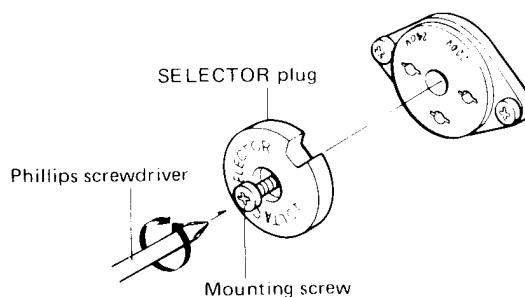

Fig. 7

120V, 220V, 240V model

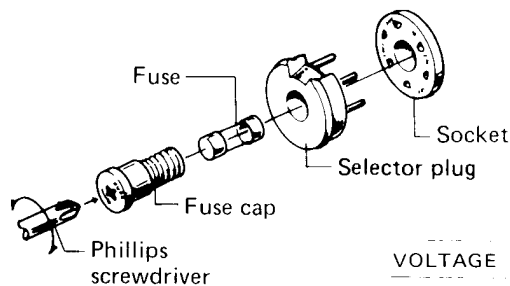

Table	
VOLTAGE	FUSE
120V	1.5A
220V 240V	800 mA

Fig. 8

Table of Leading Brands of Tapes	Tableau des Principales marques de bande	Tabelle der Führende Bandmarken
----------------------------------	--	---------------------------------

This table shows the proper settings for both the tape selector and bias adjustment knob for all leading brands of tapes.

Ce tableau mentionne les réglages appropriés du sélecteur de bande et du bouton de réglage de polarisation pour les bandes de marque les plus courantes.

Diese Tabelle zeigt die richtige Einstellung des Bandsortenwählers und des Vormagnetisierungs-Feineinstellknopfes für die wichtigsten Tonbandmarken.

Brand of tape	Bias control position	Tape selector position	
BASF	LH C-60	-2.5	STD
	LH C-90	-2	
	LN C-60	-4.5	
	LN C-90	-2	
	LH SUPER C-60	-2.5	
	LH SUPER C-90	-2	
	SLH I C-60	+1	
LH I C-60	0		
AGFA	LOW NOISE C-60	-2.5	
	LOW NOISE C-90	-2	
	SUPER FERRO DYNAMIC C-60 +6	-2	
	SUPER FERRO DYNAMIC C-90 +6	-0.5	
	SUPER COLOR C-60, C-90	-1.5	
SCOTCH	LH C-60, C-90	-3	
	CRYSTAL C-60, C-90	0	
	MASTER 120 μ s C-60, C-90	+0.5	
TDK	D C-60, C-90	-2.5	
	SD C-60, C-90	-2	
	ED C-60, C-90	-2	
	AD C-60, C-90	+1	
MAXELL	LN C-60	-2	
	LN C-90	-1.5	
	UL C-60	-1	
	UL C-90	-1.5	
	UD C-60, C-90	+1	
	UD XLI C-60, C-90	0	
FUJI	FL C-60, C-90	-2.5	
	FX C-60	0	
	FX C-80, C-90	0	
	FX Jr C-60, C-90	+0.5	
	FX DUO C-60, C-90	0	
	Range 2 C-60, C-90	0	
	Range 4 C-60, C-90	0	
Range 6 C-60	-2		
SONY	LN C-60	-2.5	
	LN C-90	-2	
	HF C-60, C-90	0	
	AHF C-60, C-90	+1	
	BHF C-60, C-90	-1	

Brand of tape	Bias control position	Tape selector position	
SONY	DUAD C-60	0	Fe-Cr
	DUAD C-90	-3.5	
	NEW DUAD C-60, C-90	0	
BASF	FERROCHROM C-60	-1.5	
	FERROCHROM C-90	-3.5	
SCOTCH	CLASSIC C-60, C-90	-4.5	
AGFA	CARAT C-60	+1.0	CrO ₂
	CARAT C-90	0	
BASF	CHROME C-60	+0.5	
	CHROME C-90	0	
	CHROMDIOXID SUPER C-60	0	
SCOTCH	MASTER 70 μ s EQ C-90	0	
TDK	SA C-60, C-90	0	
	NEW SA C-60, C-90	0	
	KR C-60, C-90	0	
MAXELL	C-60 CR, C-90 CR	0	
	UD XLII C-60, C-90	-0.5	
FUJI	FC C-60	-0.5	
	FC C-90	0	
SONY	CR C-60, C-90	+1	
	JHF C-60, C-90	+1	
SCOTCH	METAFINE C-46	+4.5	METAL

- NOTE: (HINWEIS:)**
- Sometimes you will get better results by choosing a different position — it depends on the tape.
 - Il se peut que parfois on obtienne de meilleurs résultats en choisissant une position différente, cela dépend de la bande.
 - Es kann vorkommen, daß in einer anderen Stellung bessere Ergebnisse erzielt werden — dieses ist von dem individuellen Kassettenband abhängig.

TROUBLESHOOTING

Although some failures and breakdowns can be traced to legitimate mechanical faults, some are in fact the results of improper maintenance, tape defects or lack of experience in operating the tape deck. If you think that there is a failure, refer first to the following checklist.

Symptom	Cause	Remedy
Tape does not run.	<ol style="list-style-type: none"> 1. AC cord is not plugged in. 2. Tape has run out. 3. PAUSE switch is set to ON. 4. Cassette is inserted improperly. 	<ol style="list-style-type: none"> 1. Plug cord correctly. 2. Rewind tape. 3. Depress PAUSE switch to OFF. 4. Remove tape and insert properly.
High frequencies are weak.	<ol style="list-style-type: none"> 1. Heads are dirty. 2. BIAS control and TAPE selector are not set in accordance with tape during recording or playback. 3. A recorded tape without using the Dolby NR system is being played back with DOLBY NR switch set to ON. 	<ol style="list-style-type: none"> 1. Clean heads. 2. Set BIAS control and TAPE selector correctly in accordance with tape. 3. Depress DOLBY NR switch to OFF.
No playback sound.	MONITOR switch is set to SOURCE.	MONITOR switch is set to TAPE.
Playback sound is distorted.	Distortion is recorded on tape.	Replace cassette tape.
Sound is unsteady.	<ol style="list-style-type: none"> 1. Dirty capstan. 2. Irregular cassette tape winding. 	<ol style="list-style-type: none"> 1. Clean capstan. 2. Replace tape.
Excessive noise.	<ol style="list-style-type: none"> 1. Tape is old. 2. Recorded tape using the Dolby NR system is being played back with DOLBY NR switch set to OFF. 	<ol style="list-style-type: none"> 1. Replace tape. 2. Depress DOLBY NR switch to ON.
Cannot record.	Cassette's erasure prevention tabs have been broken off.	Replace tape or cover tab openings with adhesive tape.
Recorded sound is distorted.	<ol style="list-style-type: none"> 1. Input level is too high. 2. Dirty heads. 	<ol style="list-style-type: none"> 1. Reduce input level. 2. Clean heads.