

# SERVICE MANUAL

## PARTS LIST

**MODEL AA-1030**



**ALSO APPLICABLE TO MODEL AA-1030L**

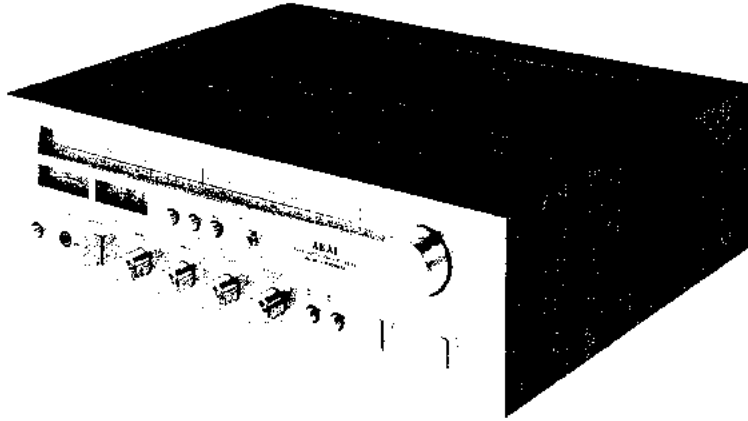

**AKAI STEREO RECEIVER**  
**MODEL AA-1030**

ALSO APPLICABLE TO MODEL AA-1030L

<b>SECTION 1</b>	<b>SERVICE MANUAL</b> .....	<b>1</b>
<b>SECTION 2</b>	<b>PARTS LIST</b> .....	<b>21</b>

---

SECTION 1

**SERVICE MANUAL**

TABLE OF CONTENTS

I. SPECIFICATIONS .....	2
II. DISMANTLING OF UNIT .....	4
III. ARRANGEMENT OF PRINCIPAL PARTS .....	5
IV. FM TUNER SECTION ADJUSTMENTS .....	6
V. AM TUNER SECTION ADJUSTMENT (Model AA-1030) .....	10
VI. MW, LW TUNER SECTION ADJUSTMENTS (Model AA-1030L) .....	11
1. LW SECTION ADJUSTMENT .....	11
2. MW SECTION ADJUSTMENT .....	11
VII. MAIN AMPLIFIER ADJUSTMENTS .....	12
VIII. TUNING CORD THREADING .....	13
IX. CLASSIFICATION OF VARIOUS P.C BOARDS .....	14
1. P.C BOARD INTERCHANGEABILITY CHART .....	14
2. COMPOSITION OF VARIOUS P.C BOARDS .....	15

For basic adjustments, measuring methods, and operating principles, refer to GENERAL OPERATING PRINCIPLES AND ADJUSTMENTS.

# I. SPECIFICATIONS

An asterisk next to a figure indicates the minimum guaranteed performance.

## 1. AMPLIFIER SECTION

CONTINUOUS POWER OUTPUT		30 watts per channel (both channels driven), minimum RMS, at 8 ohms load impedance from 20 to 20,000 Hz, with no more than 0.3% total harmonic distortion.
POWER BAND WIDTH (IHF)		10 to 60,000 Hz/8 ohms, distortion within 0.5%
INPUT SENSITIVITY	PHONO-1, 2 TAPE-1, 2 AUX	3mV (-48 dBm $\pm$ 1.5 dB) with output 26 dBm, 8 ohms as standard 150 mV (-14.5 dBm $\pm$ 1.5 dB) with output 26 dBm, 8 ohms as standard 150 mV (-14.5 dBm $\pm$ 1.5 dB) with output 26 dBm, 8 ohms as standard
RESIDUAL NOISE		Less than 1.4 mV (Less than -55 dBm)
SIGNAL TO NOISE RATIO	PHONO-1, 2 TAPE-1, 2 AUX	Better than 80 dB IHF (Less than -40 dBm input shorted) Better than 90 dB IHF (Less than -50 dBm input open) Better than 90 dB IHF (Less than -50 dBm input 5 k ohms shorted)
TONE CONTROL	BASS TREBLE	10 $\pm$ 1.5 dB/-10 $\pm$ 1.5 dB at 100 Hz 10 $\pm$ 1.5 dB/-10 $\pm$ 1.5 dB at 10 kHz
LOUDNESS CONTROL		10 $\pm$ 1.5 dB at 100 Hz 6 $\pm$ 1.5 dB at 10 kHz
FILTER	LOW HIGH	-7.5 $\pm$ 1.5 dB at 50 Hz -8.5 $\pm$ 1.5 dB at 10 kHz
PHONO FREQUENCY RESPONSE		RIAA $\pm$ 1 dB *13.11 $\pm$ 1.0 dB at 100 Hz *-13.75 $\pm$ 1.0 dB at 10 kHz
CHANNEL SEPARATION (IHF)		Better than 55 dB *Better than 50 dB
CROSS TALK		Better than 50 dB
L-R DEVIATION		Within 3 dB
RECORDING OUTPUT	PIN DIN	150 mV (-14.5 dBm $\pm$ 1.5 dB) 26 mV (-29 dBm $\pm$ 1.5 dB)

## 2. FM TUNER SECTION

FREQUENCY RANGE		88 to 108 MHz *87.4 to 109 MHz
DIAL TRACKING ERROR		$\pm$ 250 kHz
SENSITIVITY (IHF)		1.9 $\mu$ V *Less than 3.2 $\mu$ V (10 dB)
SENSITIVITY DEVIATION		Within 3 dB
IMAGE REJECTION RATIO		Better than 65 dB at 98 MHz *Better than 50 dB (IHF)
IF REJECTION RATIO		Better than 90 dB at 98 MHz *Better than 80 dB (IHF)
CAPTURE RATIO (IHF)		Less than 1.5 dB
LIMITING SENSITIVITY		Less than 10 dB (Audio output -1 dB)
MUTING SENSITIVITY		20 $\pm$ 10 dB MUTE LEVEL MIN. 50 $\pm$ 10 dB MUTE LEVEL MAX.
SELECTIVITY (IHF)		Better than 70 dB
AM SUPPRESSION RATIO		Better than 45 dB
SIGNAL TO NOISE RATIO		Better than 70 dB *Better than 50 dB (Stereo) including carrier leak *Better than 60 dB (Mono)
DISTORTION FACTOR		Less than 0.4% (Stereo) *Less than 1.0% (Stereo) Less than 0.2% (Mono) *Less than 0.5% (Mono)
FREQUENCY RESPONSE		-13 $\pm$ 1 dB at 10 kHz (US-A) -10.5 $\pm$ 1 dB at 10 kHz (US-B)
STEREO SENSITIVITY		5.6 $\mu$ V (15 $\pm$ 3 dB)
STEREO SEPARATION		Better than 40 dB
L-R DEVIATION		Within 3 dB
RECORDING OUTPUT	PIN DIN	390 mV (-6 dBm $\pm$ 3 dB) 70 mV (-21 dBm $\pm$ 3 dB)

### 3. AM(MW) TUNER SECTION

FREQUENCY RANGE	535 to 1,605 kHz *500 to 1,650 kHz	
DIAL TRACKING ERROR	Within 2%	
SENSITIVITY (IHF)	200 $\mu$ V/m (Bar Antenna) 5 $\mu$ V (EXT Antenna) *320 $\mu$ V/m (Bar Antenna)	
SENSITIVITY DEVIATION	Within 6 dB	
IMAGE REJECTION RATIO	Better than 60 dB at 1,000 kHz *Better than 50 dB at 1,000 kHz	
IF REJECTION RATIO	Better than 60 dB at 1,000 kHz *Better than 50 dB at 1,000 kHz	
SELECTIVITY (IHF)	Better than 30 dB at $\pm$ 10 kHz	
SIGNAL TO NOISE RATIO	Better than 50 dB *Better than 45 dB	
DISTORTION FACTOR	Less than 0.6% *Less than 1.5%	
FREQUENCY RESPONSE	-15 dB at 3 kHz	
RECORDING OUTPUT	PIN	220 mV (-11 dBm $\pm$ 2 dB)
	DIN	43 mV (-25 dBm $\pm$ 2 dB)

### 4. AM(LW) TUNER SECTION

FREQUENCY RANGE	150 to 350 kHz	
DIAL TRACKING ERROR	Within 2%	
SENSITIVITY (IHF)	1 mV/m (Bar Antenna) 15 $\mu$ V (EXT Antenna)	
IMAGE REJECTION RATIO	Better than 30 dB at 240 kHz	
IF REJECTION RATIO	Better than 30 dB at 240 kHz	
SELECTIVITY (IHF)	Better than 30 dB at $\pm$ 10 kHz	
SIGNAL TO NOISE RATIO	Better than 35 dB	
DISTORTION FACTOR	Less than 3%	
RECORDING OUTPUT	PIN	155 mV (-14 dBm $\pm$ 2 dB)
	DIN	35 mV (-27 dBm $\pm$ 2 dB)

### 5. OTHER

TRANSISTOR	2SA640(I)(P)(Q)(R) ... 4 2SA733(Q)(R) ... 1 2SA815(O)(Y) ... 2 2SB558(O)(Y) ... 2 2SC930(E)(F) ... 1 2SC945L(K)(P)(Q)(R) ... 10	2SC1222(E)(F)(G) ... 8 2SC1625(O)(Y) ... 2 2SC1628(O)(Y) ... 4 2SD234(O)(Y) ... 2 2SD428(O)(Y) ... 2
IC	LA1230 ... 1 LA3350 ... 1	$\mu$ PC30C ... 1
DIODE	1N4003 ... 3 1S2473 ... 3 SEL102R ... 3	STV-4H ... 2 WZ130 ... 1 HIFI-SPECIAL 400V ... 4
POWER REQUIREMENT	110 Volts/220 Volts/240 Volts 50/60 Hz Switchable 120 Volts 60 Hz CSA (AA-1030 only) 220 Volts 50 Hz CEE (AA-1030 only)	
DIMENSIONS	440(W)x140(H)x350(D)mm (17.3"x5.5"x13.8") including all protruding parts	
WEIGHT	13 kg (28.6 lbs)	

NOTE: Specifications subject to change without notice.

## II. DISMANTLING OF UNIT

In case of trouble, etc. necessitating disassembly, please disassemble in the order shown in photographs. Reassemble in reverse order.

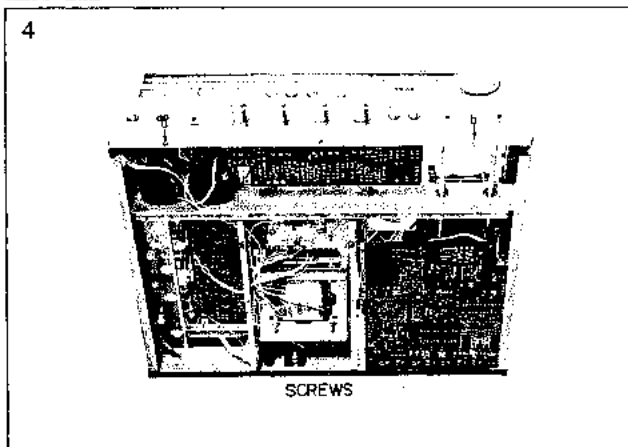
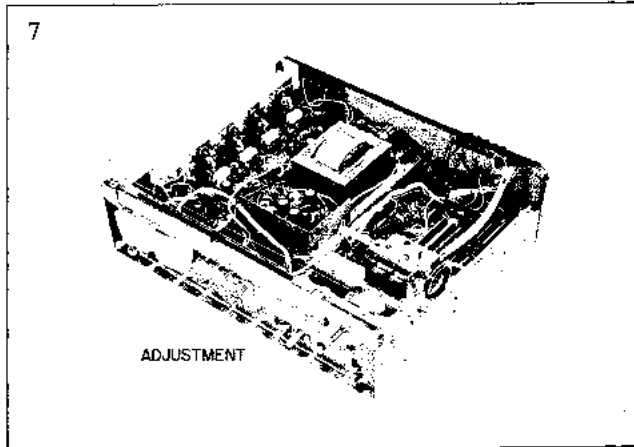
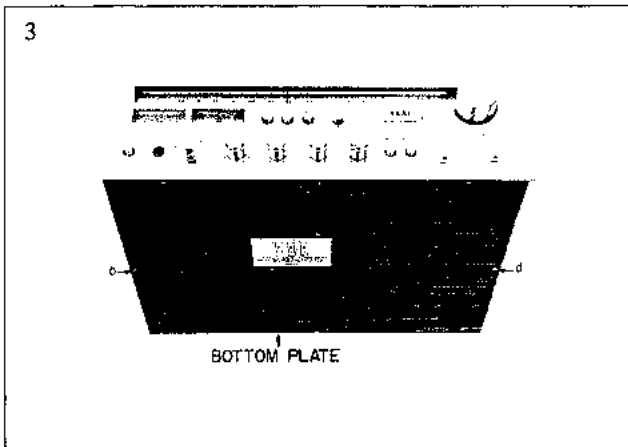
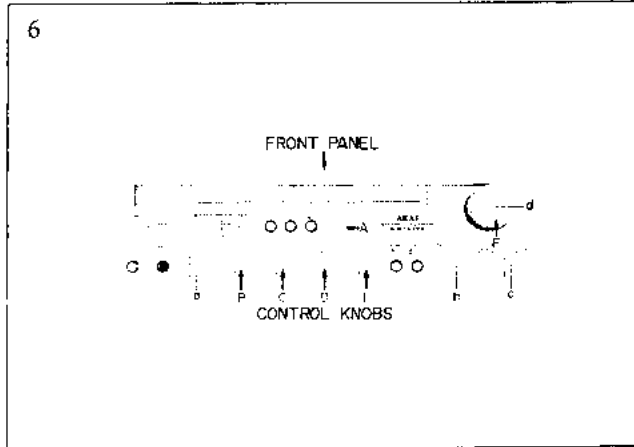
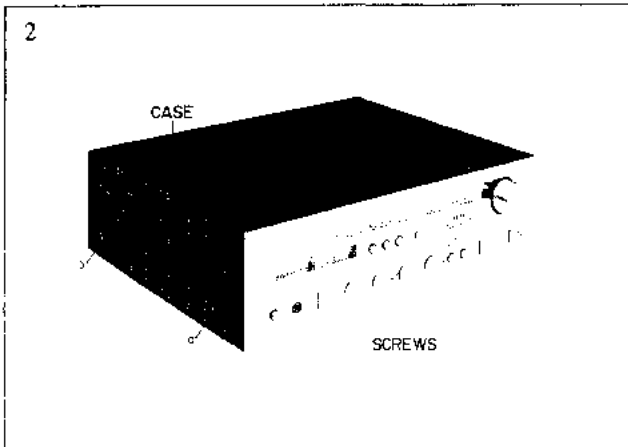
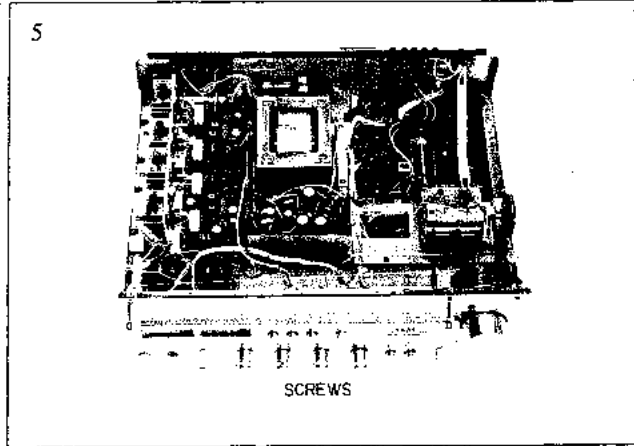
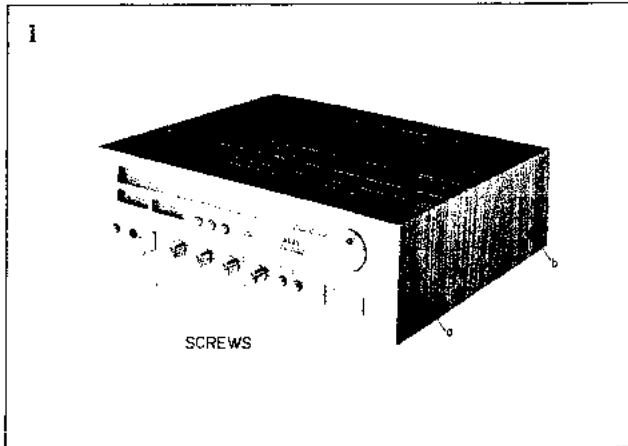

### III. ARRANGEMENT OF PRINCIPAL PARTS

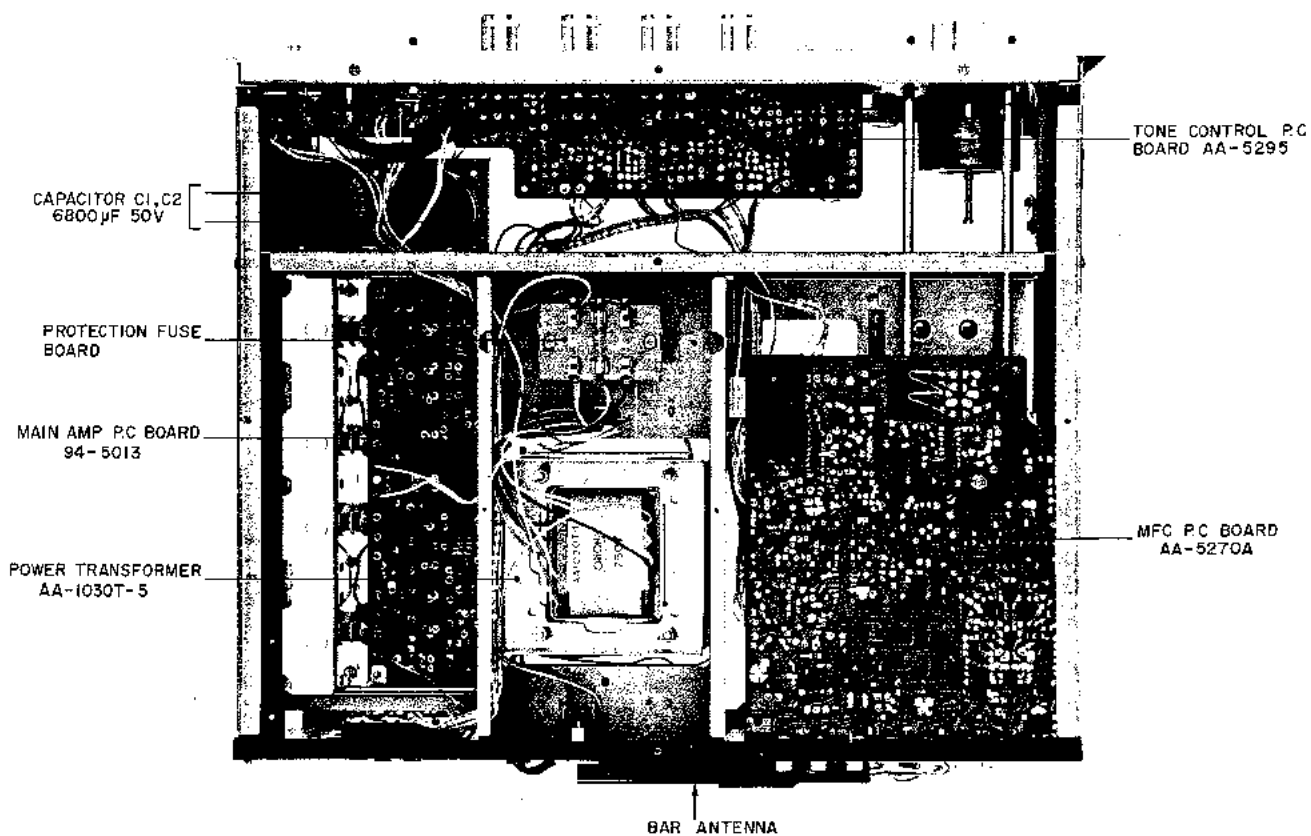
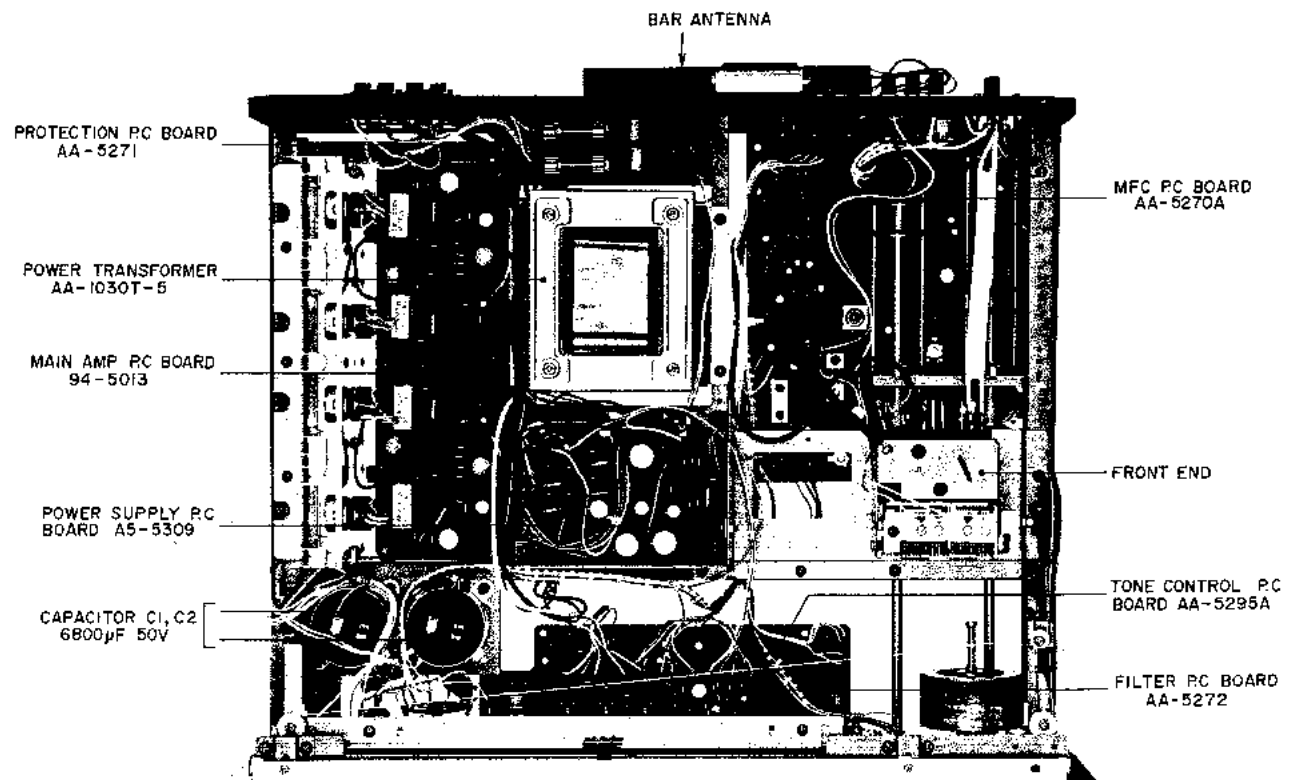

# IV. FM TUNER SECTION ADJUSTMENTS

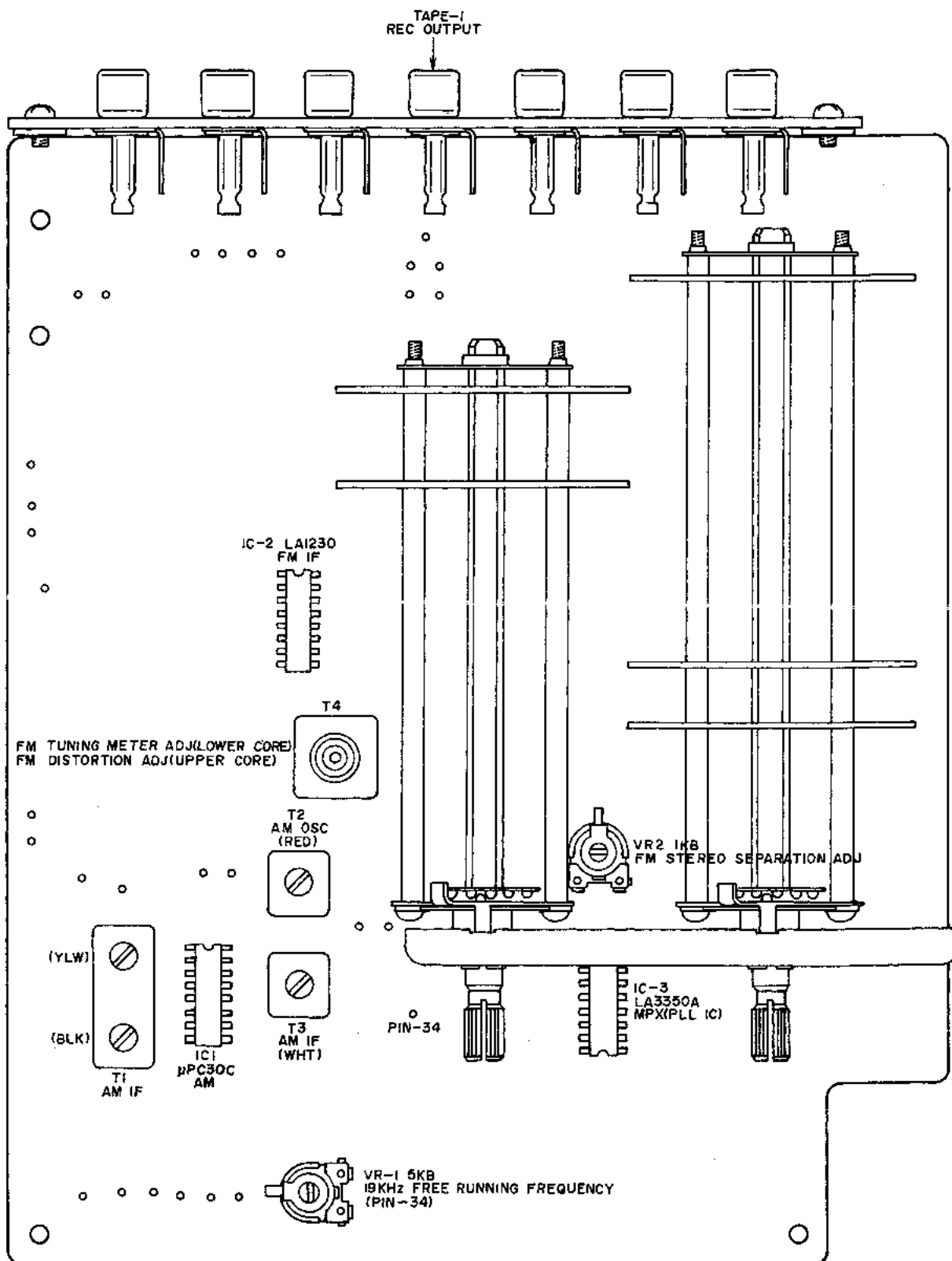

Fig. 1 MFC P.C Board AA-5270A (AA-1030)



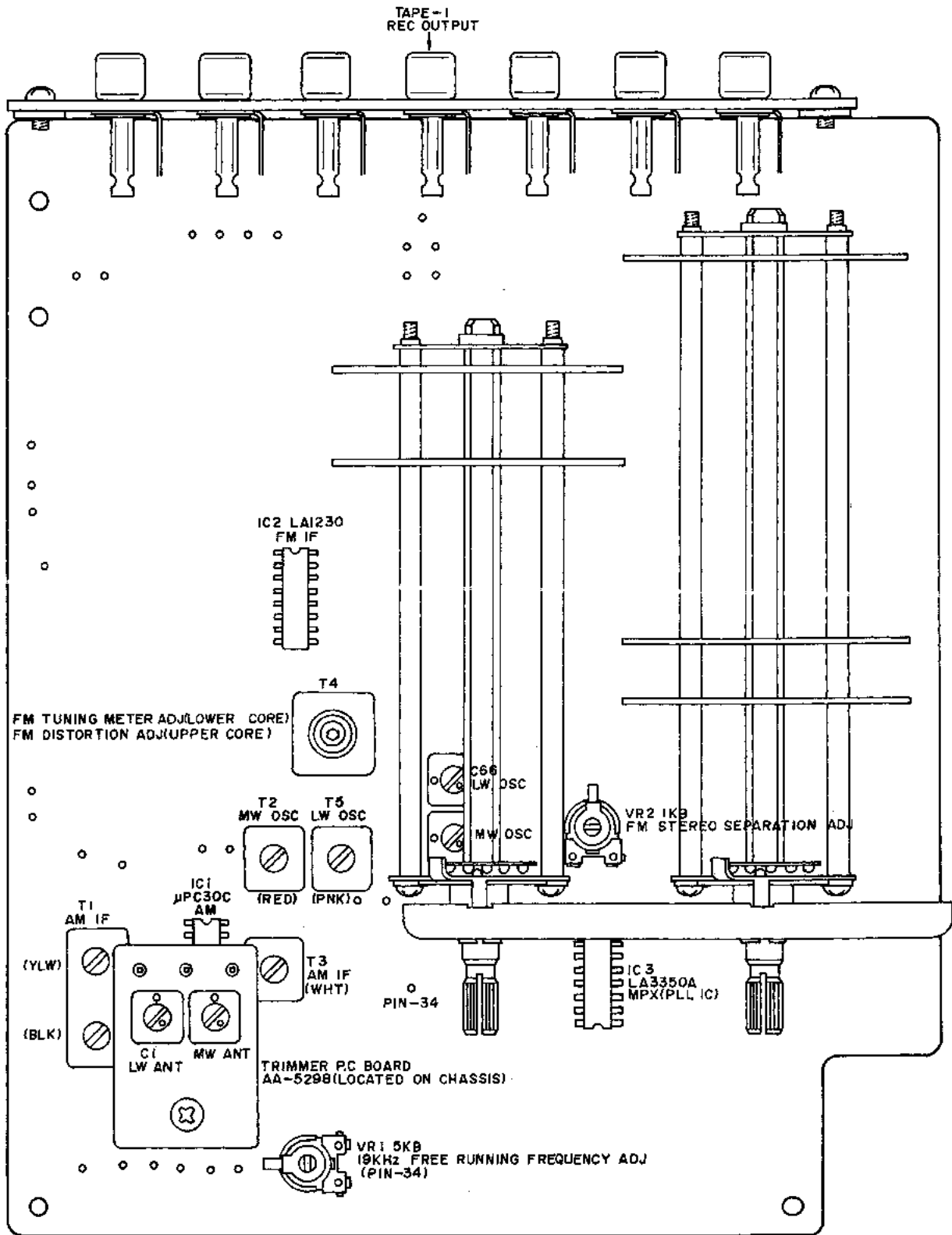

Fig. 2 MFC P.C Board AA-5270A (AA-1030L)

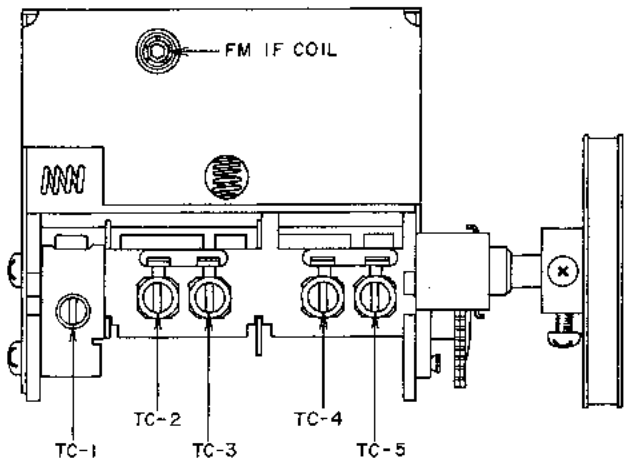

Fig. 3 Front End (AA-1030)

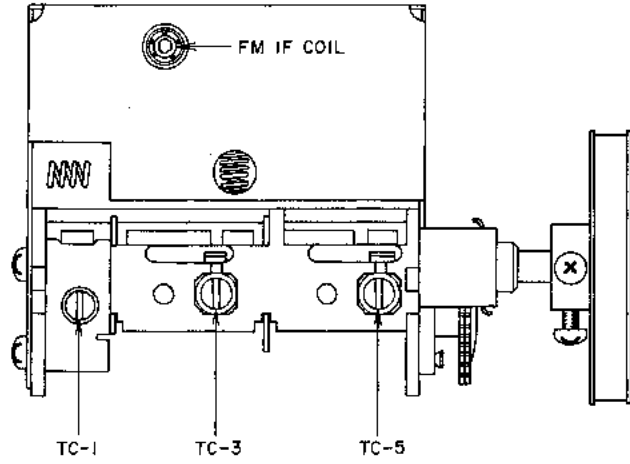

Fig. 4 Front End (AA-1030L)

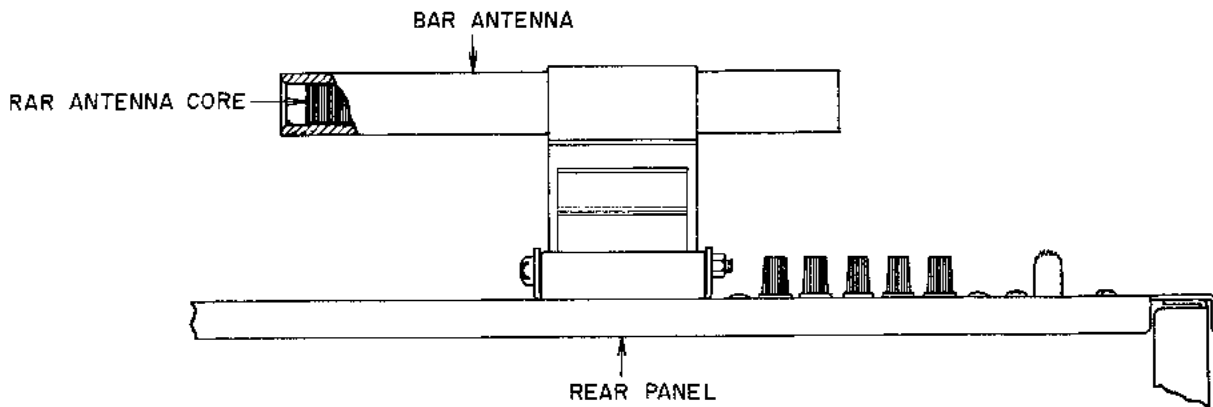

Fig. 5 Model AA-1030

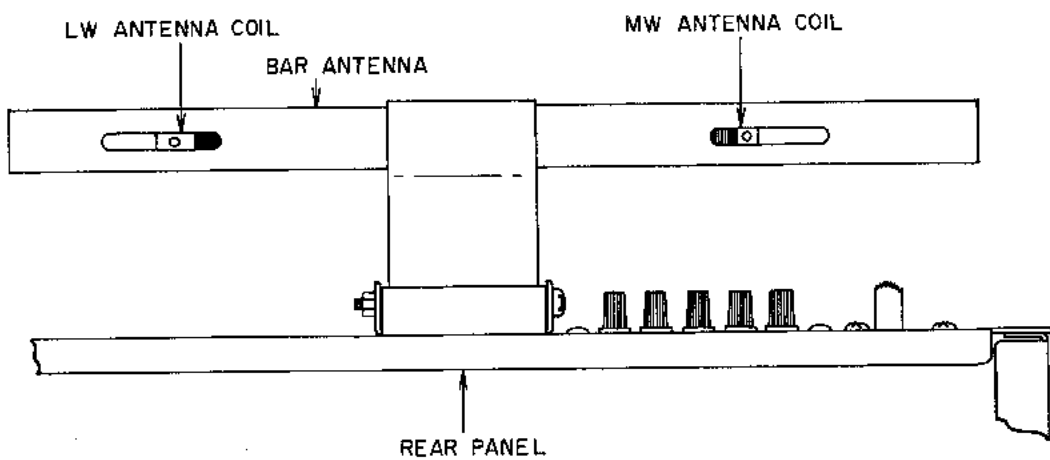

Fig. 6 Model AA-1030L

Step	Adjustment Item	Adjustment Point	Result	Remarks
1	Front End IF coil Adjustment	IF Coil (Front End)	Maximum Noise Level	SELECTOR to "FM AUTO" Tune only noise (without broad- cast interference).
2	Tuning Meter Centering	T-4 Lower Side Core (MFC P.C Board)	Center Indication of Tuning Meter	Same as above.
3	Distortion Factor Adjustment	T-4 Upper Side core (MFC P.C Board)	Less than 0.5% Distortion Factor	108 MHz, 60 dB (mono) input Less than 0.5% on both chan- nels.
4	Confirmation of Tuning Meter Centering			If Tuning Meter indication is not at center position re-adjust STEP-2 & 3 above.
5	Frequency Coverage Adjustment	TC-1 (Front End)		108 MHz, 60 dB (mono) input error: within $\pm 250$ kHz
6	Sensitivity Adjustment	TC-3, TC-5 (Front End)	Less than 3% Distortion Factor	108 MHz, Less than 10 dB (mono) input.
7	Low Range Sensitivity Confirmation		Less than 3% Distortion Factor	88 MHz, Less than 10 dB (mono) input. error: within $\pm 250$ kHz See NOTE-1.
8	Mid Range Sensitivity Confirmation		Less than 3% Distortion Factor	98 MHz, Less than 10 dB (mono) input See NOTE-1.
9	PLL IC Free Running Frequency Adjustment	VR-1 5 kB (MFC P.C Board)	19.00 kHz	Mute Switch to "ON". Frequency Counter to PIN-34 (MFC P.C Board) See NOTE-2
10	Stereo Indicator Lighting Confirmation			Failure of stereo indicator to light means that stereo broad- casts are not being received.
11	Stereo Separation Adjustment	VR-2 1 kB (MFC P.C Board)	More than 40 dB	98 MHz, 60 dB (stereo), L-ch Input distortion factor must be less than 1.0%.
12	Stereo Separation Adjustment		More than 40 dB	98 MHz, 60 dB (stereo), R-ch input distortion factor must be less than 1.0% and if it exceeds 1.0%, adjust the coil in STEP-1 within a half-turn.
13	FM Mute Confirmation		Mute Volume at Max: $50 \pm 10$ dB Min: $20 \pm 10$ dB	98 MHz (mono) input
14	Confirmation of Tuning Meter and Signal Meter Indication		Tuning Meter: Center Signal Meter: Maximum	Signal Meter indicates from 3 to 4 on scale at 60 dB input.

Chart-1

NOTE-1 In the event that the distortion factors in STEP-7 & 8 are not less than 3%, re-adjust Front End Trimmers TC-3 & TC-5 to obtain an average minimum distortion factor of under 3% at 88, 98 & 108 MHz.

NOTE-2 Free running frequency of the PLL IC must be an exact 19.00 kHz.

## V. AM TUNER SECTION ADJUSTMENT (Model AA-1030)

Step	Adjustment Item	Adjustment Point	Result	Remarks
1	Low Range Frequency Coverage Adjustment	T-2 (RED) (MFC P.C Board)	Error: within 2%	520 kHz, optional input
2	Sensitivity Adjustment	Bar antenna core T-1 (YLW, BLK) T-3 (WHT) (MFC P.C Board)	Maximum Sensitivity	520 kHz, optional input
3	High Range Frequency Coverage Adjustment	TC-2 (Front End)	Error: within 2%	1,400 kHz, optional input
4	Sensitivity Adjustment	TC-4 (Front End)	Maximum Sensitivity	1,400 kHz, optional input

Chart-2

NOTE: Repeat procedures in STEP-1 through STEP-4.

## VI. MW, LW TUNER SECTION ADJUSTMENTS (Model AA-1030L)

### 1. LW SECTION ADJUSTMENT

Step	Adjustment Item	Adjustment Point	Result	Remarks
1	Low Range Frequency Coverage Adjustment	T-5 (PNK) (MFC P.C Board)	Error: within 2%	160 kHz, optional input
2	Sensitivity Adjustment	Bar Antenna LW Coil T-1 (YLW, BLK) T-3 (WHT) (MFC P.C Board)	Maximum Sensitivity	160 kHz, optional input
3	High Range Frequency Coverage Adjustment	C-66 LW OSC trimmer (MFC P.C Board)	Error: within 2%	340 kHz, optional input
4	Sensitivity Adjustment	C-1 LW ANT trimmer (Trimmer P.C Board)	Maximum Sensitivity	340 kHz, optional input

Chart-3

### 2. MW SECTION ADJUSTMENT

Step	Adjustment Item	Adjustment Point	Result	Remarks
1	Low Range Frequency Coverage Adjustment	T-2 (MFC P.C Board)	Error: within 2%	520 kHz, optional input
2	Sensitivity Adjustment	Bar Antenna MW Coil	Maximum Sensitivity	520 kHz, optional input
3	High Range Frequency Coverage Adjustment	C-66 MW OSC trimmer (MFC P.C Board)	Error: within 2%	1,400 kHz, optional input
4	Sensitivity Adjustment	C-1 MW ANT trimmer (Trimmer P.C Board)	Maximum Sensitivity	1,400 kHz, optional input

Chart-4

## VII. MAIN AMPLIFIER ADJUSTMENTS

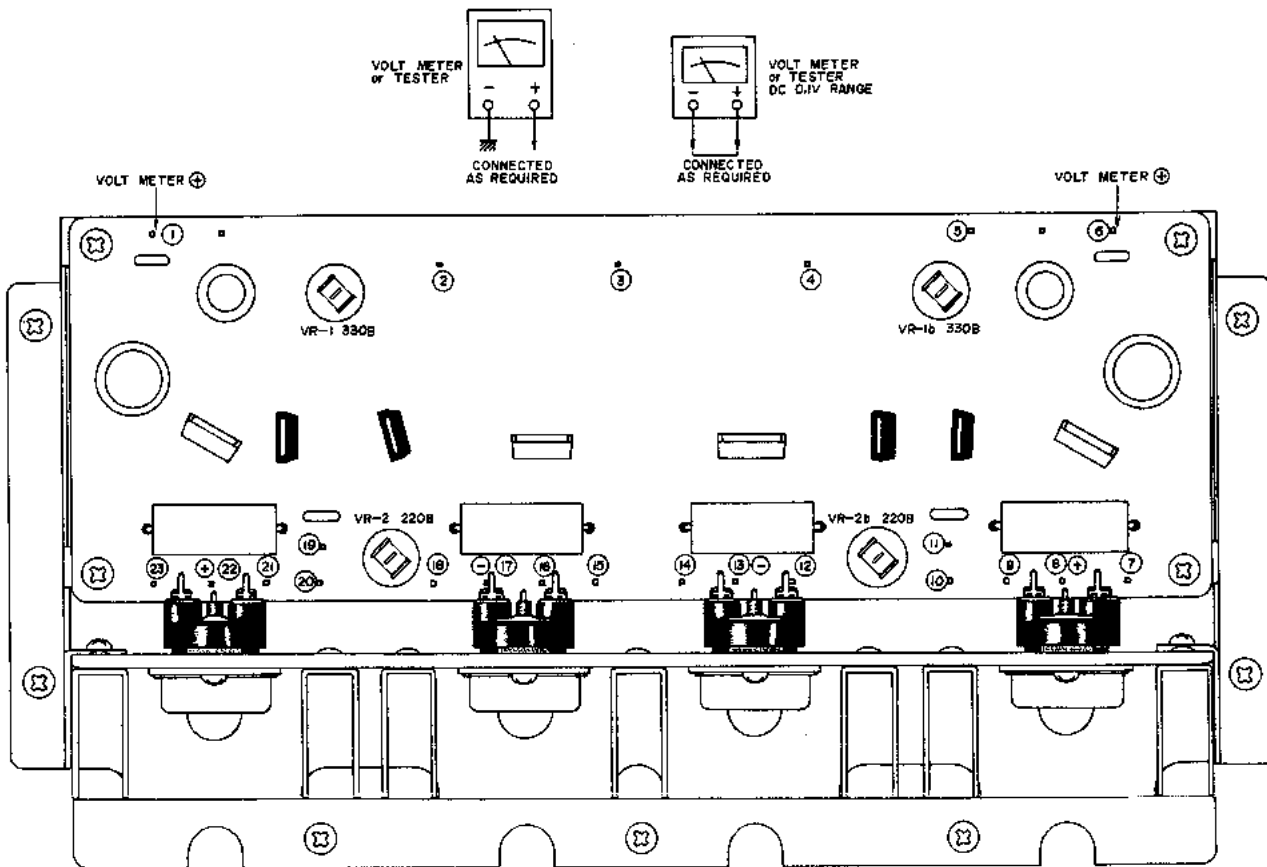

Fig. 7 Main Amplifier P.C Board 94-5013

### 1) Idling Current Adjustment

- a. Set voltmeter or tester to DC 0.1V range and connect between terminals (22) and (17) (left channel), (8) and (13) (Right channel) of main amplifier P.C Board.
- b. Adjust Main amplifier P.C Board semi-fixed resistors VR-2 220B (Left channel) and VR-2b 220B (Right channel) to obtain 30 mV on both channels.

### 2) Zero electrical potential adjustment

- a. Set voltmeter or tester to DC 1.5V range and connect between terminals (1) (Left channel), (6) (Right channel) of Main amplifier P.C Board and chassis.
- b. Adjust Main amplifier P.C Board semi-fixed resistors VR-1 330B (Left channel), VR-1b 330B (Right channel) to obtain Zero voltmeter indication.

# VIII. TUNING CORD THREADING

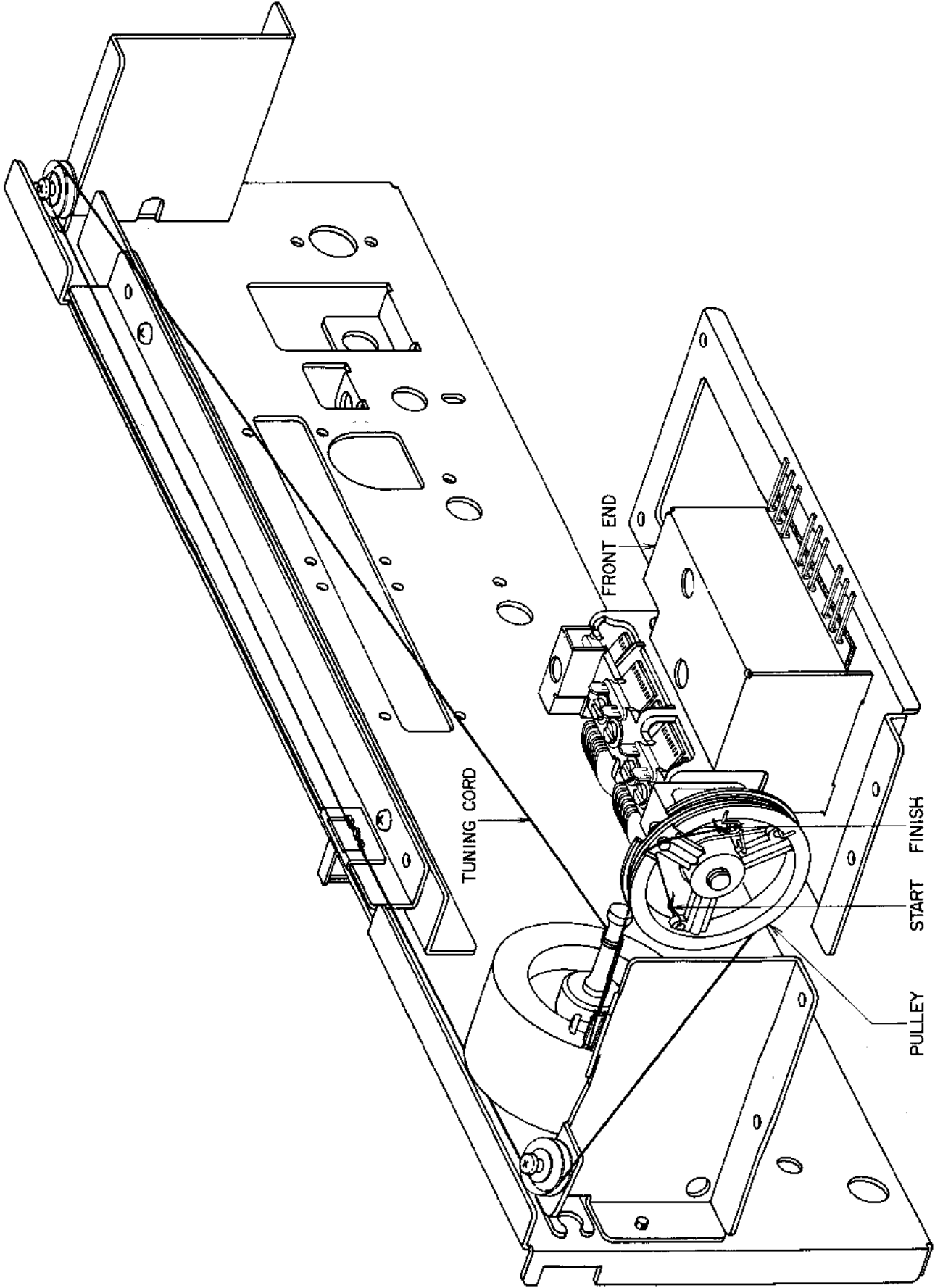

Fig. 8

# IX. CLASSIFICATION OF VARIOUS P.C BOARDS

---

## 1. P.C BOARD INTERCHANGEABILITY CHART

P.C Board	AA-1030	AA-1030L
MFC P.C Board	AA-5270A	*AA-5270A
Main Amp P.C Board	94-5013	94-5013
Power Supply P.C Board	A5-5309	*A5-5309
Filter/Mute P.C Board	AA-5272	AA-5272
Tone Control P.C Board	AA-5295A	AA-5295A
LED P.C Board	AA-5270B	AA-5270B
Protection P.C Board	AA-5271	AA-5271
Trimmer P.C Board		AA-5298

Chart-5

Asterisk mark indicates non-interchangeability.



## 2. COMPOSITION OF VARIOUS P.C BOARDS

- 1) MFC P.C BOARD AA-5270A (AA-1030)
- MFC P.C BOARD AA-5270A (AA-1030L)

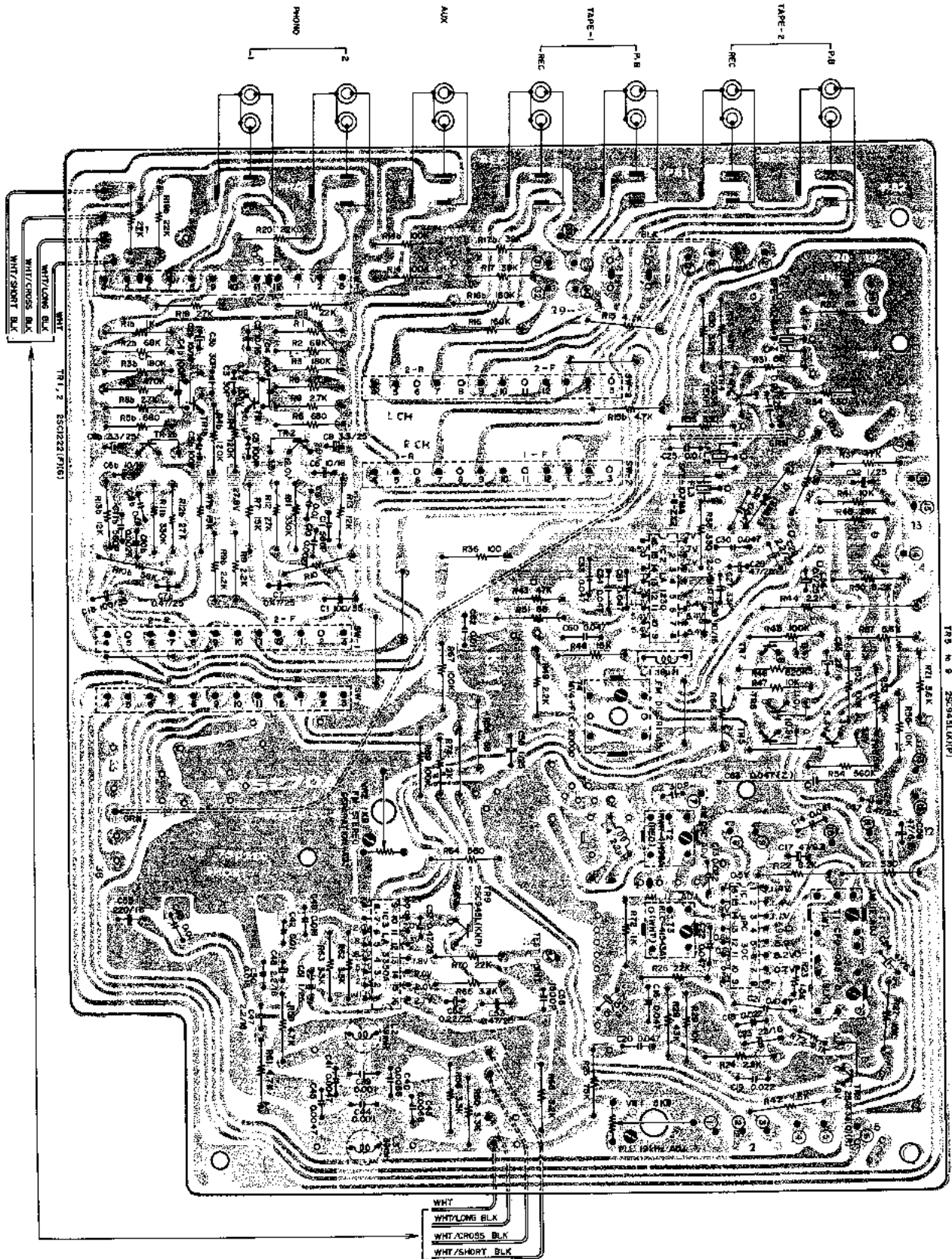

AA-1030

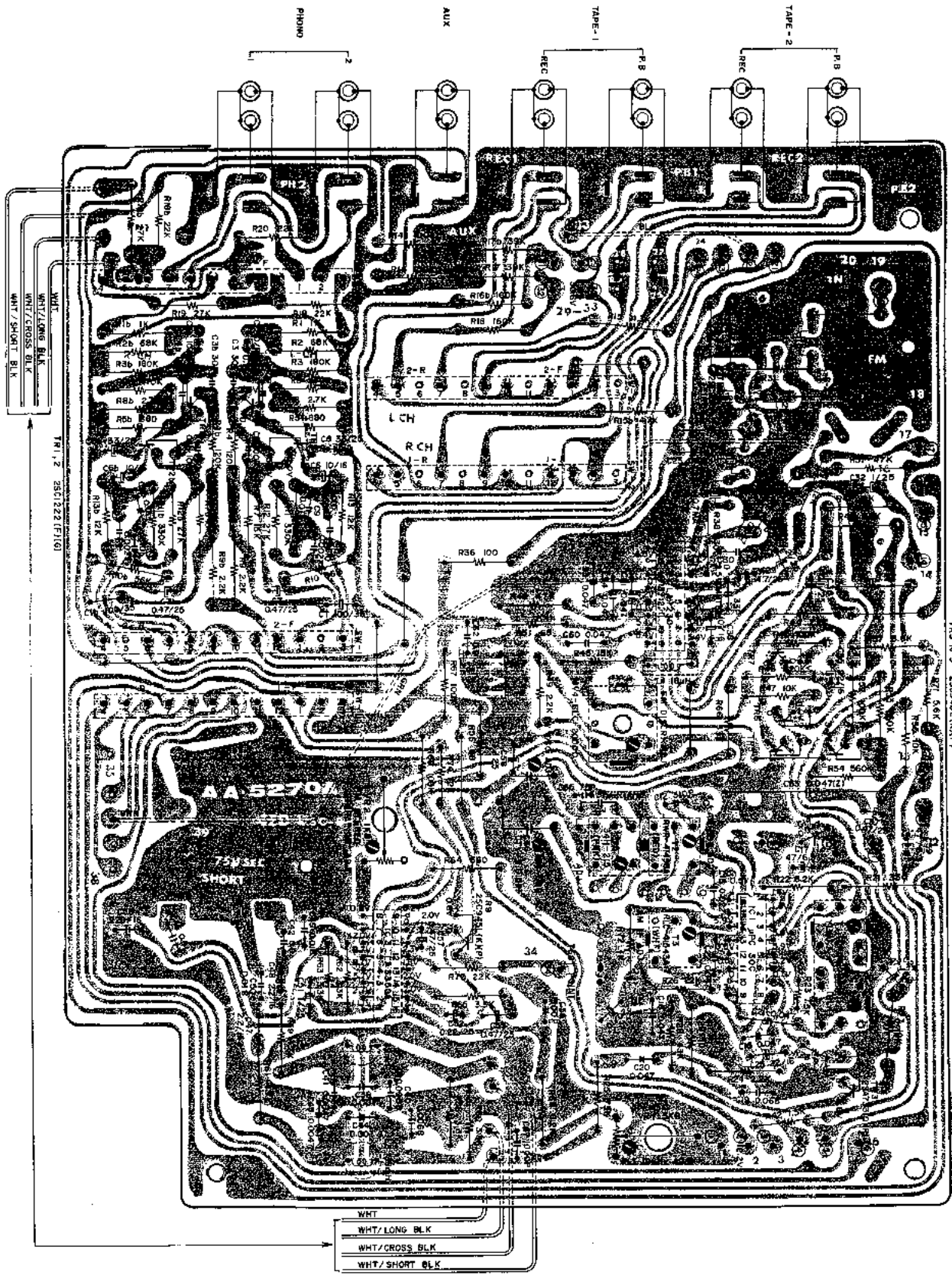

AA-1030L

2) MAIN AMP P.C BOARD 94-5013

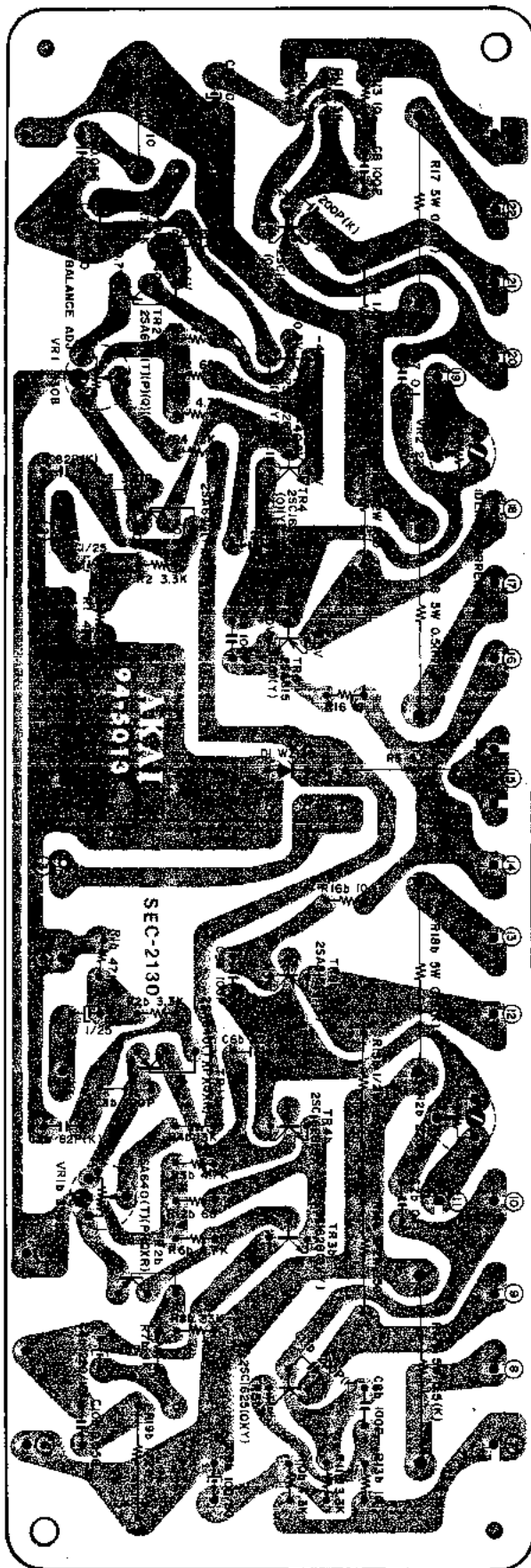

3) POWER SUPPLY P.C BOARD A5-5309

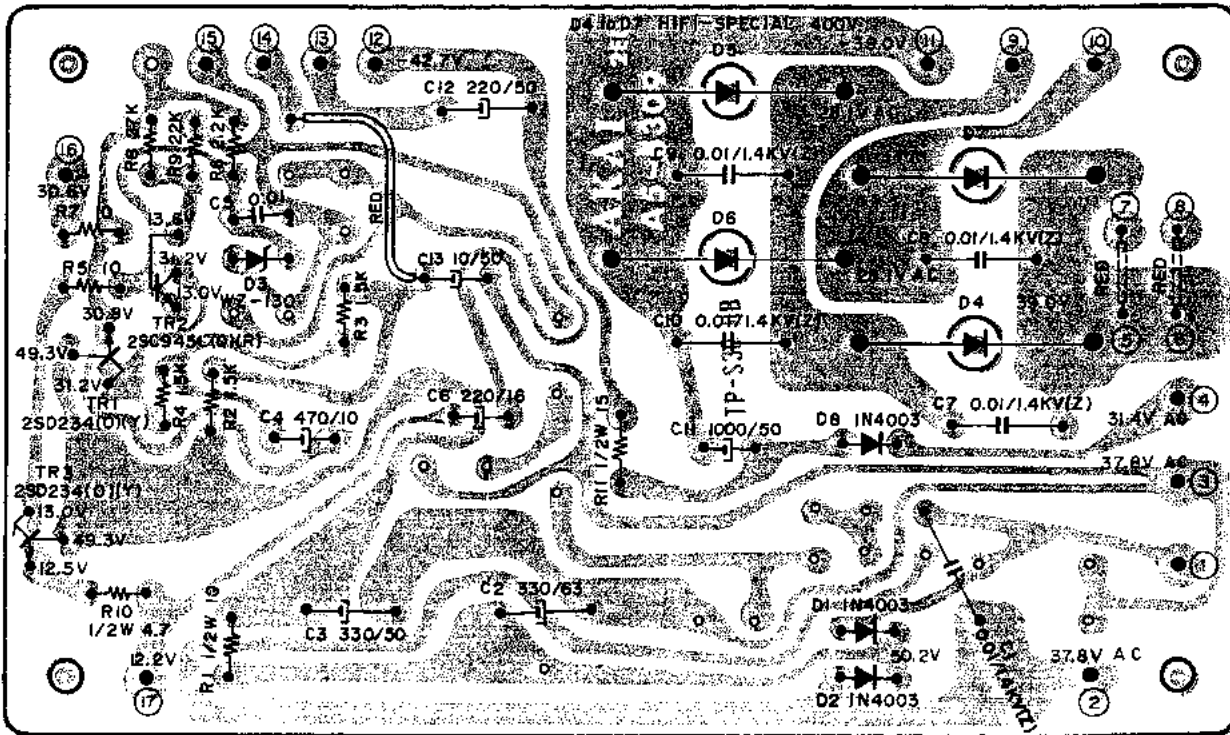

4) FILTER/MUTE P.C BOARD AA-5272

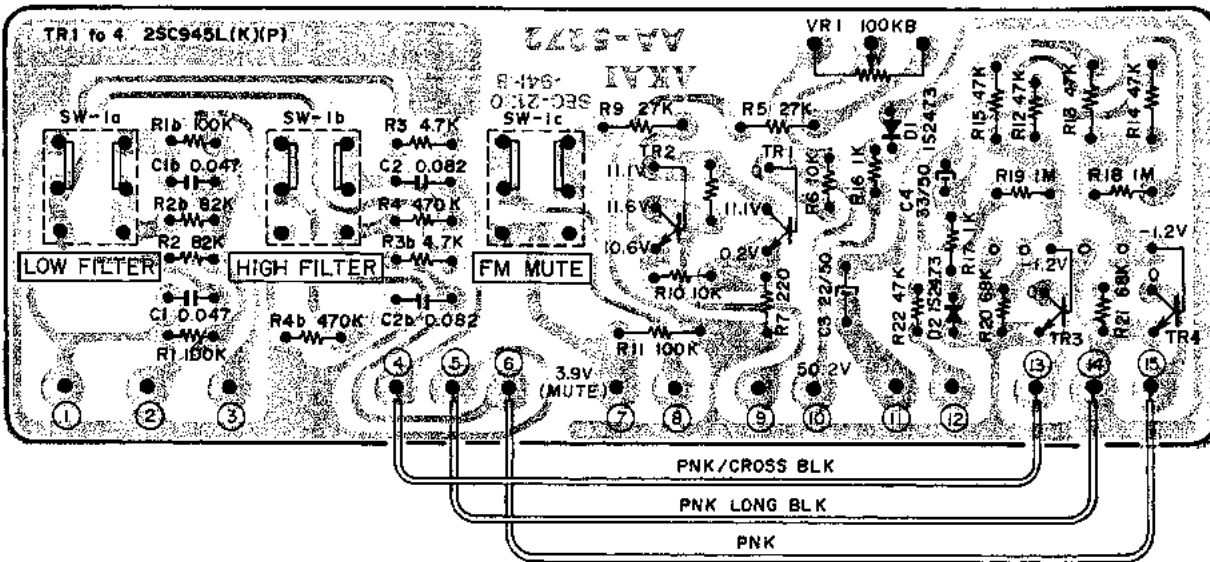

5) TONE CONTROL P.C BOARD AA-5295A

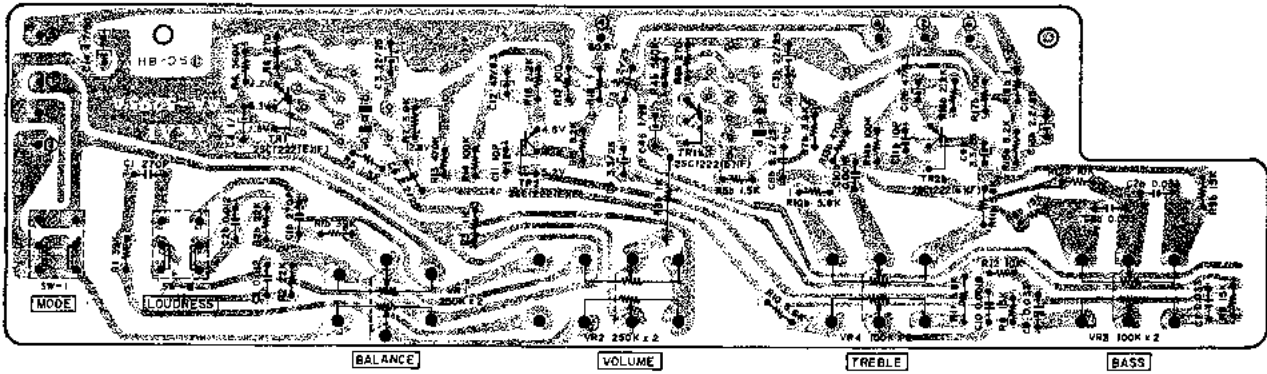

6) LED P.C BOARD AA-5270B

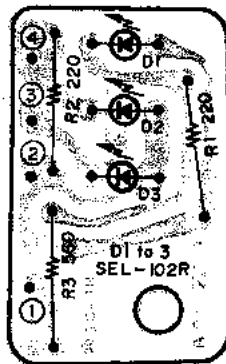

7) PROTECTION P.C BOARD AA-5271

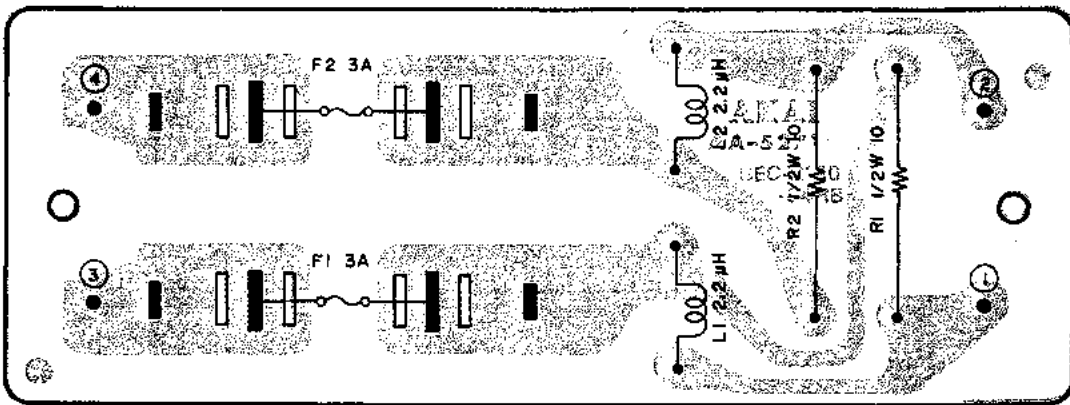

8) TRIMMER P.C BOARD AA-5298 (AA-1030L)

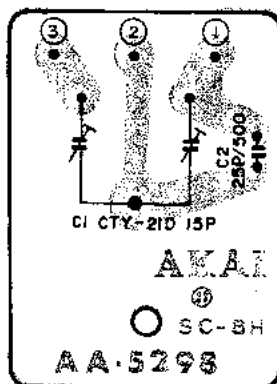

---

---

SECTION 2

**PARTS LIST**

TABLE OF CONTENTS

1. MULTI FUNCTION P.C BOARD (AA-5270A) BLOCK .....	24
2. MAIN AMP P.C BOARD (94-5013) BLOCK .....	25
3. POWER SUPPLY P.C BOARD (A5-5309) BLOCK .....	25
4. FILTER MUTE P.C BOARD (AA-5272) BLOCK .....	25
5. TONE CONTROL P.C BOARD (AA-5295A) BLOCK .....	25
6. LED P.C BOARD (AA-5270B) BLOCK .....	25
7. PROTECTION P.C BOARD (AA-5271) BLOCK .....	26
8. TRIMMER P.C BOARD (AA-5298) BLOCK .....	26
9. ASSEMBLY BLOCK .....	27
10. FINAL ASSEMBLY BLOCK .....	30
11. LIST OF INTERCHANGEABLE SEMICONDUCTORS .....	31
INDEX .....	32

Some of the parts in this parts list are only available as a complete assembly, and can not be supplied as individual parts.

## HOW TO USE THIS PARTS LIST

1. This parts list is compiled by various individual blocks based on assembly process.
2. When ordering parts, please describe parts number, serial number, and model number in detail.
3. How to read list.













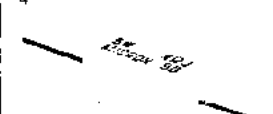





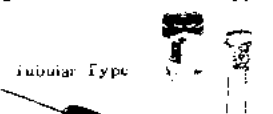

The reference number corresponds with illustration or photo number of that particular parts list.  
 This number corresponds with the Figure Number.  
 This number corresponds with the individual parts index number in that figure.  
 A small "x" indicates the inability to show that particular part in the Photo or Illustration.  
 Schematic Diagram Number of individual manufactured part.  
 (not required for parts order)  
 Quantity of particular part required.

Ref. No.	Parts No.	Description	Schematic No.	Q'ty
<b>FLYWHEEL BLOCK #13</b>				
12-115x	800425	Flywheel Block Assy. Comp.	RDC #13	1
12-116	244506	Flywheel Only	RD 22	1
12-117x	244754	Felt, Flywheel	RD 35	1
12-118	251324	Main Metal Case	RD 26	1
12-119	253080	Main Metal	RD 27	1

4. The symbol numbers shown on the P.C. Board list can be matched with the Composite Views of components of the Schematic Diagram or Service Manual.
5. The indications of Resistors and Capacitors in the photos of P.C. Board are being eliminated.
6. The shape of the parts and parts name, etc. can be confirmed by comparing them with the parts shown on the Electrical Parts Table of P.C. Board.
7. Both the kind of part and installation position can be determined by the Parts Number. To determine where a parts number is listed, utilize Parts Index at end of Parts List.  
 It is necessary first of all to find the Parts Number. This can be accomplished by using the Reference Number listed at right of parts number in the Parts Index. (meaning of ref. no. outlined in Item 3 above).
8. Utilize separate "Price List for Parts" to determine unit price. The most simple method of finding parts Price is to utilize the reference number.



## ELECTRICAL PARTS TABLE

<p>Because the indication of resistors and capacitors in the P. C. Board photos are being eliminated, please confirm parts name and shape by comparing them with the parts shown in this table.</p>	<p>1</p>  <p style="text-align: center;">Solid Resistor</p>	<p>2</p> <p style="text-align: right;">Stopper Type</p>  <p style="text-align: center;">Carbon Resistor</p>	<p>3</p>  <p style="text-align: center;">Metal Oxide Film Resistor</p>
<p>4</p>  <p style="text-align: center;">Cement Resistor</p>	<p>5</p>  <p style="text-align: center;">Wire-Wound Resistor</p>	<p>6</p>  <p style="text-align: center;">Thermister</p>	<p>7</p>  <p style="text-align: center;">Enamel Resistor</p>
<p>1</p>  <p style="text-align: center;">MP Capacitor (Tubular Type)</p>	<p>2</p>  <p style="text-align: center;">Plastic Capacitor</p>	<p>3</p>  <p style="text-align: center;">Mylar Capacitor</p>	<p>4</p>  <p style="text-align: center;">VFM (Hi-Q) Capacitor</p>
<p>5</p>  <p style="text-align: center;">Mylar Capacitor</p>	<p>6</p>  <p style="text-align: center;">Tantalum Capacitor</p>	<p>7</p>  <p style="text-align: center;">Oil Capacitor (Tubular Type)</p>	<p>8</p> <p style="text-align: right;">Vertical Type</p>  <p style="text-align: center;">Styrol Capacitor</p>
<p>9</p>  <p style="text-align: center;">Electrolytic Capacitor (Tubular Type)</p>	<p>10</p> <p style="text-align: right;">Vertical Type</p> <p style="text-align: left;">Tubular Type</p>  <p style="text-align: center;">Electrolytic Capacitor</p>	<p>11</p>  <p style="text-align: center;">Ceramic Capacitor</p>	<p>12</p>  <p style="text-align: center;">Metalized Mylar (Paper) Capacitor</p>
<p>13</p>  <p style="text-align: center;">Trimmer Condenser</p>		<p>VR</p>  <p style="text-align: center;">Semi-Fixed Volume</p>	
<p>L</p>  <p style="text-align: center;">Ferri Inductor</p>	<p>TR</p>  <p style="text-align: center;">Transistor</p>		
<p>CR</p>  <p style="text-align: center;">Spark Quencher</p>	<p>D</p>  <p style="text-align: center;">Diode (Silicon, Zener, Germanium)</p>		

# 1 MULTI FUNCTION P.C BOARD (AA-5270A) BLOCK

Symbol No.	Parts No.	Description	Q'ty
1-1	BA649372	Multi Function P.C Board Comp. (AA-5270A)	1
1-2	BA670746	Multi Function P.C Board Comp. (AA-5270A)(1030L)	1
1-IC1	EI650362	I.C MPC-30C	1
1-IC2	EI650586	I.C LA-1230	1
1-IC3	EI650597	I.C LA-3350	1
1-TR1,2	ET650316	Transistor 2SC1222(F)(G)	4
1-TR3	ET557965	Transistor 2SA733(Q)(R)	1
1-TR4	ET618873	Transistor 2SC930(E)(F)	1
1-TR5to9	ET635220	Transistor 2SC945L(K)(P)	5
1-D1	ED624903	Silicon Diode 1S2473	1
1-SW1	ES664244	Rotary SW. SR26N5-17-6 225 KC (1030L)	1
1-SW1	ES650283	Rotary SW. SR26N 3-9-6 22.5 KC	1
1-SW2	ES650305	Rotary SW. SR26N 2-4-5 22.5 KC	1
1-T1	EO650384	AM-IF Trans. CFU-085-D 468 kHz	1
1-T2	EO650395	OSC. Coil RWR-41498A	1
1-T3	EO650373	AM-IF Trans. RLC-41543A 468 kHz	1
1-T4	EO650608	Discri Coil MV4-FLC-20000	1
1-T5	BT633025	LW OSC. Trans. 34H-215	1
1-VR1	EV484863	Semi-fixed/Vol. V10K8-4-2 1 KB (Metalized Film)	1
1-VR2	EV499364	Semi-fixed/Vol. V10K8-4-2 5 KB	1
1-L1	E0650610	Inductor 144LZ 18μH(J)	1
1-L2,3	E0650428	Inductor 39 MH(J)	2
1-L4	E0539820	Peaking Coil 2.2μH(K)	1
1-FL1to3	ER650430	Ceramic Filter SFE-10.7 MA-8-Z	3
1-3	EJ650272	Pin Jack 14P JPJ379 1 1	1
1-4	TA646738	Switch Support	1
1-5	ZS422076	Screw, pan head 3x5	1
1-6	EJ539662	Wrapping Post 1x17	31
		Capacitor, Vertical Type	
1-C1	EC455354	Elect. 100μF 35WV	2
1-C2	EC320051	Elect. 10μF 16WV	2
1-C3	EC556018	VFM 30PF(K) 50WV	2
1-C4,5	EC290531	VFM 100PF(K) 50WV	4
1-C6	EC320051	Elect. 10μF 16WV	2
1-C7	EC622991	Elect. 0.47μF 25WV	2
1-C8	EC331828	Elect. 3.3μF 25WV	2
1-C9	EC650340	Ceramic DD312A 0.01μF(J) 50WV	2
1-C10	EC650351	Ceramic DD360A 0.0027μF(J) 50WV	2
1-C11	EC433697	VFM 560PF(J) 50WV	2
1-C12	EC650406	Styrol 310PF(J) 50WV	1
1-C13	EC650417	Ceramic DD380-950-BC 0.022μF(M) 50WV	1
1-C14	EC427228	Ceramic DD111FZ 0.047μF(Z) 50WV	1
1-C15	EC329782	Elect. 220μF 10WV	1
1-C16	EC427228	Ceramic DD111FZ 0.047μF(Z) 50WV	1
1-C17	EC329771	Elect. 47μF 6.3WV	2
1-C18	EC650417	Ceramic DD380-950-BC 0.022μF(M) 50WV	1
1-C18	EC658012	Ceramic DD310-950-BC 0.047μF(M) 50WV (1030L)	1
1-C19	EC650417	Ceramic DD380-950-BC 0.022μF(M) 50WV (1030L)	1
1-C19	EC683144	Ceramic DD310-950-BC 0.068μF(M) 50WV (1030L)	1
1-C20to22	EC427228	Ceramic DD111FZ 0.047μF(Z) 50WV	3
1-C23	EC331705	Elect. 22μF 16WV	1
1-C24	EC329771	Elect. 47μF 6.3WV	2
1-C25,26	EC650340	Ceramic DD312-A 0.01μF(J) 50WV	2
1-C27	EC650463	Ceramic RD204-NPO 33PF(K) 50WV	1
1-C28	EC220432	Elect. 2.2μF 25WV	1
1-C29	EC450527	Elect. 4.7μF 25WV	1

Symbol No.	Parts No.	Description	Q'ty
1-C30,31	EC427228	Ceramic DD111FZ 0.047μF(Z) 50WV	2
1-C32	EC450055	Elect. 1μF 25WV	1
1-C33,34	EC427228	Ceramic DD111FZ 0.047μF(Z) 50WV	2
1-C35	EC331705	Elect. 22μF 16WV	1
1-C36	EC523282	Solid Aluminum 0.1μF(M) 25WV	1
1-C37	EC368256	Elect. 0.47μF 25WV	1
1-C38	EC320051	Elect. 10μF 16WV	1
1-C39	EC650474	Ceramic DD340-257-A 0.001μF(J) 50WV	1
1-C40	EC650496	Ceramic DD310-A 0.0068μF(J) 50WV	1
1-C41	EC650485	Ceramic DD380-A 0.0047μF(J) 50WV	1
1-C42	EC551441	Ceramic DD106FZ 0.01μF(Z) 50WV	1
1-C43	EC650496	Ceramic DD310-A 0.0068μF(J) 50WV	1
1-C44	EC650474	Ceramic DD340-257-A 0.001μF(J) 50WV	1
1-C45	EC650485	Ceramic DD380-A 0.0047μF(J) 50WV	1
1-C46	EC551441	Ceramic DD106FZ 0.01μF(Z) 50WV	1
1-C47,48	EC556007	Elect. 2.2μF 16WV	2
1-C49,50	EC389485	Mylar 0.018μF(J) 50WV	2
1-C51	EC450055	Elect. 1μF 25WV	1
1-C52	EC522167	Solid Aluminum 0.22μF(M) 25WV	1
1-C53	EC621257	Solid Aluminum 0.47μF(M) 25WV	1
1-C55	EC321208	Elect. 220μF 16WV	1
1-C56	EC666483	Styrol 1500PF(K) 50WV	1
1-C57	EC368256	Elect. 0.47μF 25WV	1
1-C58	EC450055	Elect. 1μF 25WV	1
1-C59	EC329771	Elect. 47μF 6.3WV	1
1-C60,61	EC427228	Ceramic DD111FZ 0.047μF(Z) 50WV	2
1-C62	EC551441	Ceramic DD106FZ 0.01μF(Z) 50WV	1
1-C63	EC427228	Ceramic DD111FZ 0.047μF(Z) 50WV	1
1-C64	EC523293	VFM 160PF(J) 50WV (1030L)	1
1-C65	EC485111	VFM 75PF(J) 50WV (1030L)	1
1-C66	EC675742	Trimmer CTY-21D 15PF (1030L)	1
1-C67	EC469708	Styrol 1000PF(J) 50WV (1030L)	1
1-C68	EC658012	Ceramic DD310-950-BC 0.047μF(M) 50WV (1030L)	1

Carbon Resistor Omitted

## 2 MAIN AMP P.C BOARD (94-5013) BLOCK

Symbol No.	Parts No.	Description	Q'ty
2-1	BA649438	Main Amp P.C Board Comp. (94-5013)	1
2-2	BA663085	Main Amp P.C Board Comp. (94-5013)(CAS)	1
2-TR1,2	ET561802	Transistor 2SA640(1)	4
2-TR3,4	ET623035	Transistor 2SC1628(O)(Y)	4
2-TR5	ET649067	Transistor 2SC1625(O)(Y)	2
2-TR6	ET649078	Transistor 2SA815(O)(Y)	2
2-D1,2	ED539976	Zener Diode WZ-130	3
2-VR1	EV551643	Semi-fixed/Vol. SR19R 330ΩB (Solid Type)	2
2-VR2	EV649642	Semi-fixed/Vol. SR19R 220ΩB	2
2-3	EJ551654	Wrapping Post 1x23	17
2-4	EJ539662	Wrapping Post 1x17	8
2-R17,18	ER653567	Cement/R. SW 0.47Ω(K) (Wire wound Type)	4
Capacitor, Vertical Type			
2-C1	EC313108	Elect. 1μF 50WV	2
2-C2	EC389024	VFM 82PF(K) 50WV	2
2-C3	EC350717	VFM 390PF(J) 50WV	2
2-C4	EC329782	Elect. 220μF 10WV	2
2-C5	EC321221	Elect. 100μF 50WV	2
2-C6	EC556525	FM 22PF(K) 500WV	2
2-C7	EC379170	Mylar 0.1μF(J) 50WV	2
2-C8,9	EC290531	VFM 100PF(K) 50WV	4
2-C10	EC368357	Mylar 0.056μF(J) 50WV	2
2-C11	EC539842	VFM 200PF(K) 50WV	2

Carbon Resistor Omitted

## 3 POWER SUPPLY P.C BOARD (A5-5309) BLOCK

Symbol No.	Parts No.	Description	Q'ty
3-1	BA649394	Power Supply P.C Board Comp. (A5-5309)	1
3-2	BA662962	Power Supply P.C Board Comp. (A5-5309) (CEE)	1
3-3	BA662973	Power Supply P.C Board Comp. (A5-5309) (CSA)	1
3-TR1	ET393568	Transistor 2SD234(Y)(O)	1
3-TR2	ET398711	Transistor 2SC945L(Q)(R)	1
3-TR3	ET393568	Transistor 2SD234(Y)(O)	1
3-D1,2	ED570295	Silicon Diode 1N4003	2
3-D3	ED539976	Zener Diode WZ-130	1
3-D4to7	ED558033	Silicon Diode HIFI Special 400V 3A	4
3-D8	ED570295	Silicon Diode 1N4003	1
3-4	TA6466874	Power Supply P.C Board Table	1
3-5	ZS325495	Tapping Screw #2 3x6(BR)	3
3-6	EZ650913	Mylar Film	1
3-7	EZ602403	Insulator Bush YN27B	1
3-8	Z8421806	Screw, pan head 3x8	1
3-9	ZW273756	Nut M3	1
3-10	EJ539662	Wrapping Post 1x17	17
Capacitor, Vertical Type			
3-C1	EC551160	Ceramic NB821-YZ 0.01μF(Z) 1.4 kWV	1
3-C2	EC603112	Elect. 330μF 63WV	1
3-C3	EC403468	Elect. 330μF 50WV	1
3-C4	EC220768	Elect. 470μF 10WV	1
3-C5	EC684718	Ceramic DD107F 0.01μF(Z) 50WV	1
3-C6	EC321208	Elect. 220μF 16WV	1
3-C7to10	EC551160	Ceramic NB821-YZ 0.01μF(Z) 1.4 kWV	4
3-C11	EC220410	Elect. 1000μF 10WV	1
3-C12	EC337533	Elect. 220μF 50WV	1

Carbon Resistor Omitted

## 4 FILTER MUTE P.C BOARD (AA-5272) BLOCK

Symbol No.	Parts No.	Description	Q'ty
4-1	BA649462	Filter Mute P.C Board Comp. (AA-5272)	1
4-TR1,2	ET635220	Transistor 2SC945L(K)(P)	2
4-TR3,4	ET635220	Transistor 2SC945L(K)(P)	2
4-D1,2	ED560912	Silicon Diode 1S2473 VE	2
4-SW1	ES650777	Push SW. 3FT-0005-FF1320	1
4-VR1	EV650801	Vol. V16L4PHN 100kB	1
4-2	EJ539662	Wrapping Post 1x17	15
Capacitor, Vertical Type			
4-C1	EC650788	Ceramic 0.047μF(K) 50WV	2
4-C2	EC650790	Ceramic DD312A 0.0082μF(K) 50WV	2
4-C3	EC357840	Elect. 22μF 50WV	1
4-C4	EC331738	Elect. 4.7μF 50WV	1
4-C5,6	EC450527	Elect. 4.7μF 25WV	2

Carbon Resistor Omitted

## 5 TONE CONTROL P.C BOARD (AA-5295A) BLOCK

Symbol No.	Parts No.	Description	Q'ty
5-1	BA658798	Tone Control P.C Board Comp. (AA-5295A)	1
5-TR1,2	ET459810	Transistor 2SC1222(E)(F)	4
5-VR1	EV650711	Co-axial 2-throw/Vol. V24L5GPHN 1Z250kx2	1
5-VR2	EV650700	Co-axial 2-throw/Vol. V24L5GPHN 3BM 250kx2	1
5-VR3,4	EV650722	Co-axial 2-throw/vol. V24L5GPHN 1 kB 100kx2	2
5-2	EJ539662	Wrapping Post 1x17.	8
Capacitor, Vertical Type			
5-C1	EC336194	VFM 270PF(J) 50WV	2
5-C2	EC650733	Ceramic DD360-950-BC 0.01μF(K)50WV	2
5-C3	EC350684	Elect. 22μF 25WV	2
5-C4	EC450055	Elect. 1μF 25WV	2
5-C6	EC220432	Elect. 2.2μF 25WV	2
5-C7,8	EC379157	Mylar 0.033μF(J) 50WV	4
5-C9	EC331828	Elect. 3.3μF 25WV	2
5-C10	EC650520	Ceramic DD360-A 0.0018μF(K) 50WV	2
5-C11	EC474671	FM 10PF(K) 50WV	2
5-C12	EC329771	Elect. 47μF 6.3WV	2
5-C13	EC220432	Elect. 2.2μF 25WV	2
5-C14	EC331738	Elect. 4.7μF 50WV	1

Carbon Resistor Omitted

## 6 LED P.C BOARD (AA-5270B) BLOCK

Symbol No.	Parts No.	Description	Q'ty
6-1	BA649484	LED P.C Board Comp. (AA-5270B)	1
6-D1to3	ED650812	Luminous Diode SEL-102R	1
6-2	TA646648	Indicator Table	1
6-3	ZS422076	Screw, pan head 3x5	1

Carbon Resistor Omitted

---

**7 PROTECTION P.C BOARD (AA-5271)  
BLOCK**

Symbol No.	Parts No.	Description	Q'ty
7-1	BA649506	Protection P.C Board Comp. (AA-5271)	1
7-2	BA663030	Protection P.C Board Comp. (AA-5271) (CEE)	1
7-L1,2	EO650823	Phase Equalizer Coil 2.2 $\mu$ H(K)	2
7-3	EJ514822	Fuse Holder, P.C Board	4
7-4	EJ539662	Wrapping Post 1x17 S-N5051	4

Carbon Resistor Omitted

**8 TRIMMER P.C BOARD (AA-5298) BLOCK  
(AA-1030L)**

Symbol No.	Parts No.	Description	Q'ty
8-1	BA670814	Trimmer P.C Board Comp. (AA-5298)	1
8-C1	EC675742	Trimmer/C. CTV-21D 15PF	1
8-C2	EC428995	FM/C. 25PF(J) 50WV	1
8-2	EJ539662	Wrapping Post 1x17	3

9 PHOTO OF ASSEMBLY BLOCK

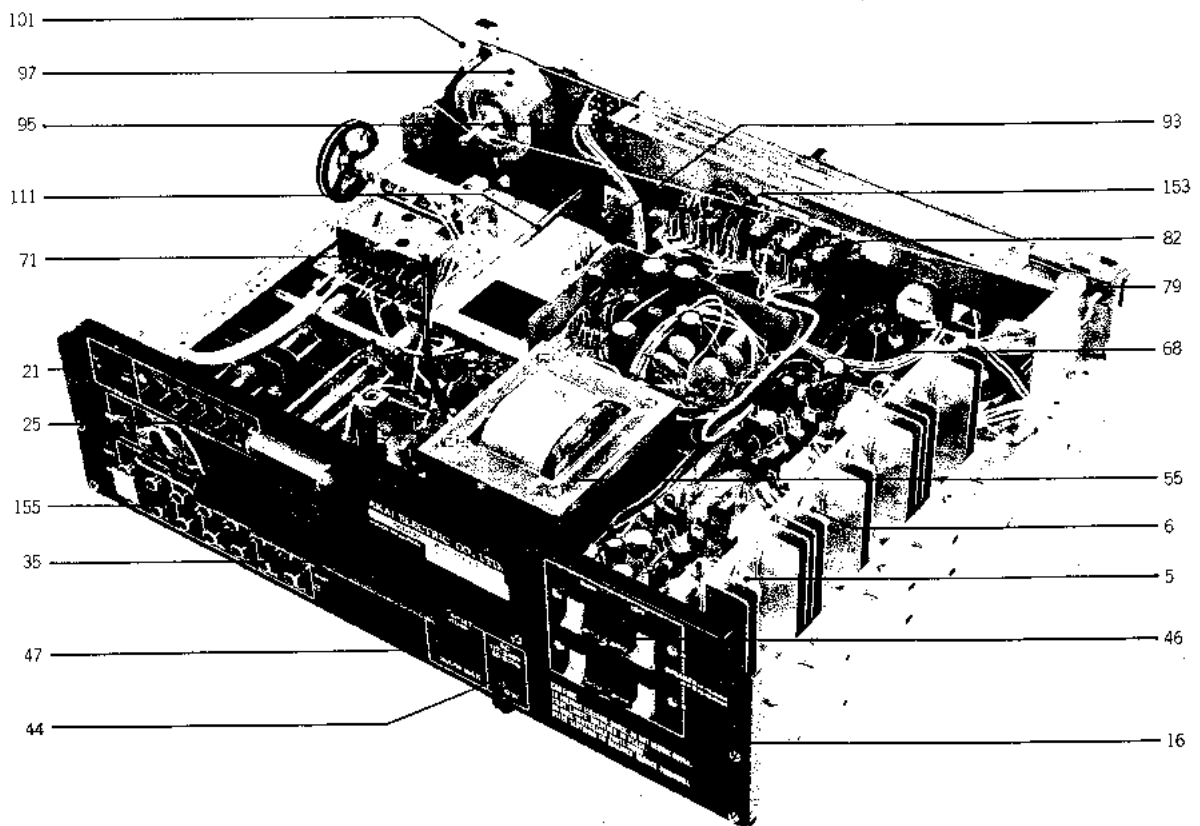
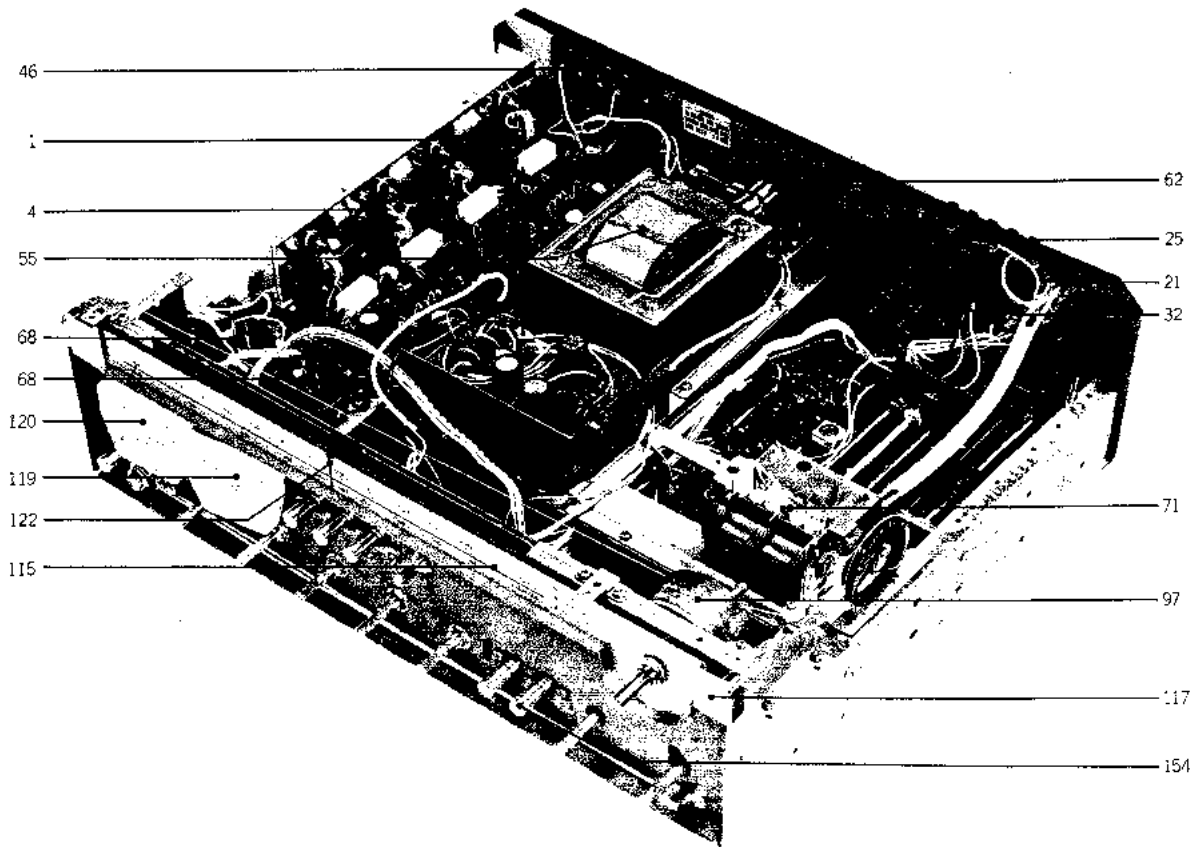

(9) ASSEMBLY BLOCK

Ref. No.	Parts No.	Description	Schematic No.	Q'ty
<b>MAIN AMP BLOCK</b>				
9-1	EZ626152	Heat-sink Plate	A5-5317	1
9-2x	EZ626141	Heat-sink Plate	A5-5316	7
9-3x	ZW414123	Hollow Rivet 3x5.9		14
9-4	EJ624486	Power TR. Socket A	31-1-97	4
9-5	ET649001	Transistor 2SD428(O)(Y)	45-1-219	2
9-6	ET649012	Transistor 2SB558(O)(Y)	45-1-220	2
9-7x	ED655097	Silicon Verister MV303YA	45-10-14	2
9-8x	ZS447840	Tapping Screw #2 3x8 (BR)		4
9-9x	EZ624734	Mylar Sheet	45 16-18	4
9-10x	ZS422965	Screw, pan head 3x15		8
9-11x	TA646536	Main Amp Support A	AA-5213	1
9-12x	TA646547	Main Amp Support B	AA-5213	1
9-13x	BA649438	Main Amp P.C Board Comp.	94-5013	1
9-14x	BA663085	Main Amp P.C Board Comp.	(CSA) 94-5013	1
9-15x	ZS325495	Tapping Screw #2 3x6(BR)	(CSA)	4
<b>REAR PANEL BLOCK</b>				
9-16	SP647932	Rear Panel 5	AA-5207	1
9-17x	SP647954	Rear Panel 7 (CEE)	AA-5207	1
9-18x	SP647943	Rear Panel 6 (CSA)	AA-5207	1
9-19x	SP675156	Rear Panel 11 (1030L)	AA-5207	1
9-20x	SP679656	Rear Panel 12 (1030L-CEE)	AA-5207	1
9-21	ES422436	Slide SW, SL-222B4C	25-3-40	1
9-22x	ER211320	Carbon/R. RD1/4W 1.5K(J) (Stop. Type)	35-10-1	2
9-23x	ER550800	Carbon/R. RD1/2W 1.5K(J) (Insu. Type)	35-9-15	2
9-24x	ZS608185	Screw, pan head 2.6x4		2
9-25	EZ655187	5P Antenna Terminal Plate	25-1-69	1
9-26x	ZS421740	Screw, pan head 3x8		6
9-27x	ZW273756	Nut M3		6
9-28x	ZW562476	Earth Lug M3		1
9-29x	SK652397	Knob 0512-2	34-1-4	1
9-30x	ZS675382	Earth Screw (1030L)	AA-52103	1
9-31x	ZW652408	Washer (SPC) D3.2x10x0.5t		1
9-32	EJ299316	Jack, 5P Din	31-1-24	1
9-33x	ZS447761	Tapping Screw #2 3x6 (BR) (Black)		4
9-34x	TA530910	Antenna Channel	91-5029	1
9-35	EE650248	Bar Antenna	55-1-25	1
9-36x	EE664233	Bar Antenna (1030L)	55-1-31	1
9-37x	TA378268	Antenna Support	AA-5552	1
9-38x	TA625847	Antenna Holder (1030L)	2-7-46	1
9-39x	ZS552600	Screw, pan head 4x50		1
9-40x	ZW273914	Spring Washer M4		2
9-41x	ZW420682	Washer (Nylon) D4.2x9x0.5t		2
9-42x	ZW345442	Washer (Nylon) D4.2x9x1t (1030L)		1
9-43x	ZW604416	Nut M4		1
9-44	EJ631945	Strain Relief SR-4N-4	2-7-49	2
9-45x	EZ246936	Strain Relief SR-6W-1 (1030L)	2-7-8	1
9-46	EJ650250	Speaker Terminal	32-1-68	2
9-47	EJ650261	AC Consent U/L S-16432	31-1-147	1
9-48x	EW374894	AC Cord CUL 3M	26-3-19	1
9-49x	EW516600	AC Cord VM-0065 (CEE)	26-3-28	1
<b>ASSEMBLY BLOCK</b>				
9-50x	TA641608	Reinforcement Channel	AA-5202	1
9-51x	TA646852	Side Plate Metal Parts	AA-5201	2
9-52x	ZS325495	Tapping Screw #2 3x6 (BR)		45
9-53x	MZ646492	Stopper	AA-5205	1
9-54x	TA646863	Transformer Table	AA-5204	1
9-55	BT665987	Power Trans. AA-1030T-5	38-4-395	1
9-56x	BT666202	Power Trans. AA-1030T-3 (CEE)	38-4-366	1
9-57x	BT666213	Power Trans. AA-1030T-2 (CSA)	38-4-365	1
9-58x	ZW273914	Spring Washer M4		4
9-59x	ZW413188	Nut M4		4
9-60x	ML668823	Angle	AA-52102	1
9-61x	TA646503	P.C Board Table	AA-5206	1
9-62	BA649506	Protection P.C Board Comp.	AA-5271	1

Ref. No.	Parts No.	Description	Schematic No.	Q'ty
9-63x	BA663030	Protection P.C Board Comp. (CEE)	AA-5271	1
9-64x	EJ551035	Wrapping Terminal, 4P T-5251	32-1-36	2
2-65x	EJ539447	Earth Terminal 2P T4460	32-1-32	1
9-66x	TA646514	Reinforcement Plate	AA-5208	1
9-67x	TA646525	Capacitor Table	AA-5209	1
9-68	EC641542	Elect. 6800µF 50WV	24-10-98	2
9-69x	TA646683	P.C Board Cushion	AA-5229	1
9-70x	TA646378	Bari. Con. Table	AA-5236	1
9-71	EE650125	Front End FB125U13	57-2-33	1
9-72x	EE664255	Front End FB125U14 (1030L)	57-2-37	1
9-73x	ZW646740	Bari. Con. Washer	AA-5237	2
9-74x	MI650136	Dial Wheel, w/spring D45	2-15-11	1
9-75x	TA207374	Thread 1.8m		1
9-76x	TC494267	Lamp Cover	CG-2206	1
9-77x	TA646582	Spacer	AA-5219	2
9-78x	MB650147	Rubber Bushing No. 6552	3-13-44	1
9-79	EL650158	Lamp 14V 100MA (200M/Mx2)(Cord Type)	28-2-48	2
9-80x	EC551160	Ceramic/C. NB821YZ 0.01µF(Z) 1.4 KWV	24-5-55	1
9-81x	EC565896	Ceramic/C. DP6600YM 0.01µF(P) 1.4 KWV (CSA)	24-5-58	1
9-82	ES665875	Push SW. SDG-1P U/L	25-5-199	1
9-83x	ES672254	Push SW. SDG-5P U/L (CEE)	25-5-207	1
9-84x	ZS422076	Screw, pan head 3x5		6
9-85x	MZ646558	SW. Table	AA-5216	1
9-86x	TA646571	Panel Support	AA-5218	2
9-87x	ZS406416	Tapping Screw #2 3x8 (Countersunk)		4
9-88x	EJ634915	Mic. Jack 3PMJ1	31-2-50	1
9-89x	ZW270191	E Jack Nut		1
9-90x	ES650182	Rorary SW. SR-321N 1-2-4 30R25-7 45		1
9-91x	ER559034	Metal Oxide Film/R. 2W 330Ω(K) 35 15 16		2
9-92x	ER668845	Carbon/R. RD1/2W 2.2M(K) (Insu. Type) (CSA)	35-9-15	1
9-93	ES650171	Push SW. 2FT-0001FF4920	25-5-184	1
9-94x	TA646560	Switch Metal Parts	AA-5217	1
9-95	BA649484	LED P.C Board Comp.	AA-5270B	1
9-96x	ZS432674	Screw, pan head 3x3		2
9-97	BF649337	Flywheel Block Comp.		1
9-98x	ZW610503	Washer D11	36-13-2	2
9-99x	ZW610492	Nut M11	36-13-3	2
9-100x	TA646593	Roller Table L	AA-5220	1
9-101	MR530651	Roller A	91-5008	2
9-102x	ZS530673	Roller Screw A	91-5010	3
9-103x	MB650147	Rubber Bushing No. 6552	3-13-44	2
9-104x	MZ664211	Roller Table R-2	AA-52104	1
9-105x	MR530662	Roller B	91-5009	1
9-106x	EL650193	Lamp 14V 100MA (650M/Mx2) (Cord Type)	28-2-47	1
9-107x	EZ610773	Fuse Angle A8	AA-5054	2
9-108x	EZ652410	Fuse Holder 3P Table	40-1-68	1
9-109x	EZ665864	Fuse Holder 5P (Large) (CSA)	40-1-60	1
9-110x	EZ665853	Fuse Holder 5P (Small) (CEE)	40-1-61	1
9-111	TA646762	Connector Bar	AA-5239	2
9-112x	ZW270123	'E' Ring 4M	6-1-9	4
9-113x	ZW260122	Washer (Nylon) D6.1x10x1t		2
9-114x	TA646773	Joint	AA-5240	2
9-115	TA647976	Scale Plate B	AA-5231	1
9-116x	TA675134	Scale Plate F (1030L-CEE)	AA-5231	1
9-117	TA648314	Lamp Reflect Plate	AA-5251	2
9-118x	EZ646626	Meter Cushion	AA-5223	2
9-119	EM664402	Tuning Meter 85C243	46-1-115	1
9-120	EM664413	Signal Meter 85C242	46-1-114	1
9-121x	TA646367	Rail	AA-5234	1
9-122	TA646795	Pointer, w/base	AA-5242	1
9-123x	ZW526577	Collar B, Jack	MC-5006	1
9-124x	ZW659147	Adjust. Washer D4.5x10x0.13t		1
9-125x	ZW659158	Adjust. Washer D4.5x10x0.25t		1
9-126x	ZW659160	Adjust. Washer D4.5x10x0.25t		1

Ref. No.	Parts No.	Description	Schematic No.	Q'ty
9-127x	ZW659171	Adjust. Washer D4.5x10x0.4t		1
9-128x	ZW659182	Adjust. Washer D4.5x10x0.4t		1
9-129x	ZW659193	Adjust. Washer D4.5x10x0.5t		1
9-130x	SZ645243	Circular Foot A	CA-6014	4
9-131x	ZS565942	Tapping Screw #2 4x8 (Pan)		4
9-132x	EJ254957	Lug Plate KP1L	33-3-2	1
9-133x	EI539447	Earth Terminal 2P T4460	32-1-32	1
9-134x	EF563657	Fuse 3A 250V	39-1-50	1
9-135x	EF557730	Fuse ULMF61M 250V 3A (CSA)	39-1-45	1
9-136x	EF601964	Fuse 1.6AT (Semko T Type) (CEE)	39-1-53	1
9-137x	EF323616	Fuse ST-2 3A	39-1-26	2
9-138x	EF666235	Fuse 3.15A (Semko) (CEE)	39-1-54	2
9-139x	EF659507	Fuse 1A 250V (CSA)	39-1-56	1
9-140x	EF683313	Fuse SS-2 0.8A 250V (CSA)	39-1-56	2
9-141x	EF593706	Fuse 500MAT (Semko T Type) (CEE)	39-1-53	1
9-142x	EF623114	Fuse 200MAT (Semko T Type) (CEE)	39-1-53	3
9-143x	EF683324	Fuse SS-2 0.4A 250V (CSA)	39-1-56	1
9-144x	ZW562476	Earth Lug M3 (CSA)		1
9-145x	EJ645928	Short Pin	AA-5263	1
9-146x	EJ205986	Cramp Terminal 2-SD	32-1-8	1
9-147x	EO539820	Peaking Coil 2.2μH(K)	23-1-187	1
9-148x	MZ229138	Wire Bundle Holder N-108	2-35-1	3
9-149x	TA646503	P.C Board Table	AA-5206	1
9-150x	EJ665818	AC Cord Repeater Terminal Plate 4P	33-2-54	1
9-151x	TA605878	Lead Protector	A3-5007	4
9-152x	SE569744	Knob Escutcheon	TD 6977	2
9-153	BA649462	Filter Mute P.C Board Comp.	AA-5272	1
9-154	SK634410	Push Button Knob J	91-5051	6
9-155	EJ650272	Pin Jack 14P JPJ379-1-1	31-1-148	1

## 10 PHOTO OF FINAL ASSEMBLY BLOCK

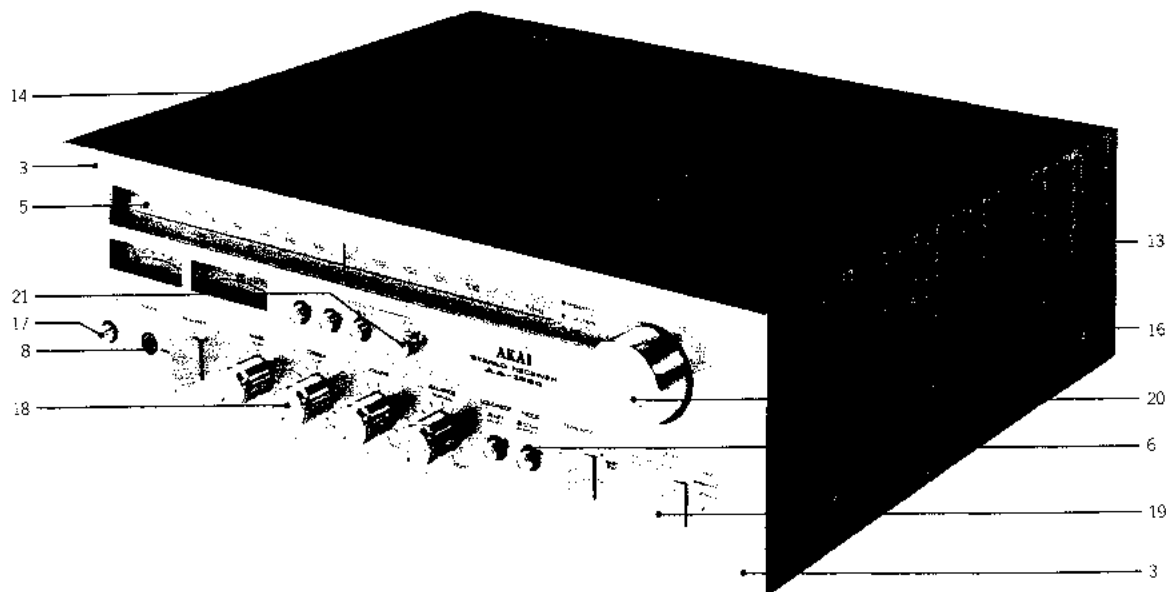

### (10) FINAL ASSEMBLY BLOCK

Ref. No.	Parts No.	Description	Schematic No.	Q'ty
<b>FRONT PANEL BLOCK</b>				
10-1x	BZ649326	Front Panel Block Comp.		1
10-2x	BZ670724	Front Panel Block Comp. (1030L)		1
10-3	SP645693	Front Panel	AA-5243	1
10-4x	SP679421	Front Panel D (1030L)	AA-5243	1
10-5	SP645715	Front Plate	AA-5245	1
10-6	SE613888	Button Escutcheon A	CW-6021	6
10-7x	MZ659777	Reflection Stopper	AA-5209	1
10-8	ZW526577	Collar B, Jack	MC-5006	1
<b>ASSEMBLY BLOCK</b>				
10-9x	SP645726	Bottom Plate	AA-5246	1
10-10x	SP664200	Bottom Plate B (CEE, CSA)	AA-5246	1
10-11x	ZS325495	Tapping Screw #2 3x6 (BR)		4
10-12x	TA646806	Fuse Cover	AA-5247	1
10-13	BC679408	Case 2	AA-52108	1
10-14	SE641597	Ventilation	AA-5249	1
10-15x	ZW548010	Spot Facing Washer	MU-6028	4
10-16	ZS510344	Screw, binding head 4x12		4
10-17	SK634410	Push Button Knob J	91-3051	6
10-18	SK646817	Single Knob	AA-5250	4
10-19	SK646830	Selector Knob	AA-5253	3
10-20	SK646828	Tuning Knob (Small)	AA-5252	1
10-21	SK646841	Single Knob (Small)	AA-5254	1



## 11 LIST OF INTERCHANGEABLE SEMICONDUCTORS

As far as service is concerned, in case the original parts cannot be obtained, the interchangeable parts listed below can be substituted.

Original Parts			Interchangeable Parts	
Description	Parts No.	Utilizing P.C Board	Description	Parts No.
2SC1222(F)(G)	ET459810	AA-5270A AA-5295A	2SC1313(G)(H)	ET604124
2SC945L(K)(P)	ET635220	AA-5270A AA-5272	2SC711(E) 2SC536(E)(F)	ET380834 ET370607
2SC930(E)(F)	ET618873	AA-5270A	2SC454(B)(C)	ET591366
2SA733(Q)(R)	ET557965	AA-5270A	2SA564(Q)(R)	ET538154
2SD234(O)(Y)	ET393568	A5-5309	2SC1060(B)(C)	ET393614
2SC945L(Q)(R)	ET398711	A5-5309	2SC711(E) 2SC536(E)(F)	ET380834 ET370607
2SA640(D)	ET561802	94-5013	2SA564(Q)(R) 2SA733(Q)(R)	ET538154 ET538378
2SC1628(O)(Y)	ET623035	94-5013	2SC1124(1)(2)	ET551564
2SC1625(O)(Y)	ET649067	94-5013	2SC1124(1)(2)	ET551564
2SA815(O)(Y)	ET649078	94-5013	2SA706-4(1)(2) 2SA706-5(1)(2)	ET551586 ET551575
2SD428(O)(Y)	ET649001	94-5013	2SC1403(O)(Y)	ET551687
2SB558(O)(Y)	ET649012	94-5013	2SA747(O)(Y) 2SA745(O)(Y)	ET551676 ET551698
1N4003	ED570295	A5-5309	10D4	ED224550
SEL-102R	ED650812	AA-5270B		
1S2473VE	ED560913	AA-5272	WG599 WG713	ED514721 ED515990
μPC30C	EI650362	AA-5270A		
LA1230	EI650586	AA-5270A		
LA3350A	EI650597	AA-5270A		
1S2473	ED624903	AA-5270A	1S1588	ED557447
MV303YA	ED655097	94-5013	STV-4H	ED551733

# INDEX

Parts No.	Ref. No. & Symbol No.	Parts No.	Ref. No. & Symbol No.	Parts No.	Ref. No. & Symbol No.	Parts No.	Ref. No. & Symbol No.	Parts No.	Ref. No. & Symbol No.
BA649372	1-1	EC455354	1-C1	EJ539662	2-4	EZ652410	9-108x	ZS447761	9-33x
BA649394	3-1	EC469708	1-C67	EJ539662	3-10	EZ655187	9-25	ZS447840	9-8x
BA649438	2-1	EC474671	5-C11	EJ539662	4-2	EZ665853	9-110x	ZS510344	10-16
BA649438	9-13x	EC485111	1-C65	EJ539662	5-2	EZ665864	9-109x	ZS530673	9-102x
BA649462	4-1	EC522167	1-C52	EJ539662	7-4	MB650147	9-78x	ZS552600	9-39x
BA649462	9-153	EC523282	1-C36	EJ539662	8-2	MB650147	9-103x	ZS565942	9-131x
BA649484	6-1	EC523293	1-C64	EJ551035	9-64x	MI650136	9-74x	ZS608185	9-24x
BA649484	9-95	EC539842	2-C11	EJ551654	2-3	ML668823	9-60x	ZS675382	9-30x
BA649506	7-1	EC551160	3-C1	EJ624486	9-4	MR530651	9-101	ZW260122	9-113x
BA649506	9-62	EC551160	3-C7 to 10	EJ631945	9-44	MR530662	9-105x	ZW270123	9-112x
BA658798	5-1	EC551160	9-80x	EJ634915	9-88x	MZ229138	9-148x	ZW270191	9-89x
BA662962	3-2	EC551441	1-C42	EJ645928	9-145x	MZ646492	9-53x	ZW273756	3-9
BA662973	3-3	EC551441	1-C46	EJ650250	9-46	MZ646558	9-85x	ZW273756	9-27x
BA663030	7-2	EC551441	1-C62	EJ650261	9-47	MZ659777	10-7x	ZW273914	9-40x
BA663030	9-63x	EC556007	1-C47, 48	EJ650272	1-3	MZ664211	9-104x	ZW273914	9-58x
BA663085	2-2	EC556018	1-C3	EJ650272	9-155	SE569744	9-152x	ZW345442	9-42x
BA663085	9-14x	EC556525	2-C6	EJ665818	9-150x	SE613888	10-6	ZW413188	9-59x
BA670746	1-2	EC565896	9-81x	EL650158	9-79	SE641597	10-14	ZW414123	9-3x
BA670814	8-1	EC603112	3-C2	EL650193	9-106x	SK634410	9-154	ZW420682	9-41x
BC679408	10-13	EC621257	1-C53	EM664402	9-119	SK634410	10-17	ZW526577	9-123x
BF649337	9-97	EC622991	1-C7	EM664413	9-120	SK646817	10-18	ZW526577	10-8
BT665987	9-55	EC641542	9-68	EO539820	1-L4	SK646828	10-20	ZW548010	10-15x
BT666202	9-56x	EC650340	1-C9	EO539820	9-147x	SK646830	10-19	ZW562476	9-28x
BT666213	9-57x	EC650340	1-C25, 26	EO650373	1-T3	SK646841	10-21	ZW562476	9-144x
BZ649326	10-1x	EC650351	1-C10	EO650384	1-T1	SK652397	9-29x	ZW604416	9-43x
BZ670724	10-2x	EC650406	1-C12	EO650395	1-T2	SP645693	10-3	ZW610492	9-99x
EC220410	3-C11	EC650417	1-C13	EO650428	1-L2, 3	SP645715	10-5	ZW610503	9-98x
EC220432	1-C28	EC650417	1-C18	EO650608	1-T4	SP645726	10-9x	ZW646740	9-73x
EC220432	5-C6	EC650417	1-C19	EO650610	1-L1	SP647932	9-16	ZW652408	9-31x
EC220432	5-C13	EC650463	1-C27	EO650823	7-L1, 2	SP647943	9-18x	ZW659147	9-124x
EC220768	3-C4	EC650474	1-C39	ER211320	9-22x	SP647954	9-17x	ZW659158	9-125x
EC290531	1-C4, 5	EC650474	1-C44	ER550800	9-23x	SP664200	10-10x	ZW659160	9-126x
EC290531	2-C8, 9	EC650485	1-C41	ER559034	9-91x	SP675156	9-19x	ZW659171	9-127x
EC313108	2-C1	EC650485	1-C45	ER650430	1-FL1 to 5	SP679421	10-4x	ZW659182	9-128x
EC320051	1-C2	EC650496	1-C40	ER653567	2-R17, 18	SP679656	9-20x	ZW659193	9-129x
EC320051	1-C6	EC650496	1-C43	ER668845	9-92x	SZ645243	9-130x		
EC320051	1-C38	EC650520	5-C10	ES422436	9-21	TA207347	9-75x		
EC321208	1-C55	EC650733	5-C2	ES650171	9-93	TA378268	9-37x		
EC321208	3-C6	EC650788	4-C1	ES650182	9-90x	TA530910	9-34x		
EC321221	2-C5	EC650790	4-C2	ES650283	1-SW1	TA605878	9-151x		
EC329771	1-C17	EC658012	1-C18	ES650305	1-SW2	TA625847	9-38x		
EC329771	1-C24	EC658012	1-C68	ES650777	4-SW1	TA641608	9-50x		
EC329771	1-C59	EC666483	1-C56	ES664244	1-SW1	TA646367	9-121x		
EC329771	5-C12	EC675742	1-C66	ES665875	9-82	TA646378	9-70x		
EC329782	1-C15	EC675742	8-C1	ES672254	9-83x	TA646503	9-61x		
EC329782	2-C4	EC683144	1-C19	ET393568	3-TR1	TA646503	9-149x		
EC331705	1-C23	EC684718	3-C5	ET393568	3-TR3	TA646514	9-66x		
EC331705	1-C35	ED539976	2-D1, 2	ET398711	3-TR2	TA646525	9-67x		
EC331738	4-C4	ED539976	3-D3	ET459810	5-TR1, 2	TA646536	9-11x		
EC331738	5-C14	ED558033	3-D4 to 7	ET557965	1-TR3	TA646547	9-12x		
EC331828	1-C8	ED560912	4-D1, 2	ET561802	2-TR1, 2	TA646560	9-94x		
EC331828	5-C9	ED570295	3-D1, 2	ET618873	1-TR4	TA646571	9-86x		
EC336194	5-C1	ED570295	3-D8	ET623035	2-TR3, 4	TA646582	9-77x		
EC337533	3-C12	ED624903	1-D1	BT633025	1-T5	TA646593	9-100x		
EC350684	5-C3	ED650812	6-D1 to 3	ET635220	1-TR5 to 9	TA646648	6-2		
EC350717	2-C3	ED655097	9-7x	ET635220	4-TR1, 2	TA646683	9-69x		
EC357840	4-C3	EE650125	9-71	ET635220	4-TR3, 4	TA646738	1-4		
EC368256	1-C37	EE650248	9-35	ET649001	9-5	TA646762	9-111		
EC368256	1-C57	EE664233	9-36x	ET649012	9-6	TA646773	9-114x		
EC368357	2-C10	EE664255	9-72x	ET649067	2-TR5	TA646795	9-122		
EC379157	5-C7, 8	EF323616	9-137x	ET649078	2-TR6	TA646806	10-12x		
EC379170	2-C7	EF557730	9-135x	ET650316	1-TR1, 2	TA646852	9-51x		
EC389024	2-C2	EF563657	9-134x	EV484863	1-VR1	TA646863	9-54x		
EC389485	1-C49, 50	EF593706	9-141x	EV499364	1-VR2	TA646874	3-4		
EC403468	3-C3	EF601964	9-136x	EV551643	2-VR1	TA647976	9-115		
EC427228	1-C14	EF623114	9-142x	FV649642	2-VR2	TA648314	9-117		
EC427228	1-C16	EF659507	9-139x	EV650700	5-VR2	TA675134	9-116x		
EC427228	1-C20 to 22	EF666235	9-138x	EV650711	5-VR1	TC494267	9-76x		
EC427228	1-C30, 31	EF683313	9-140x	EV650722	5-VR3, 4	ZS325495	3-5		
EC427228	1-C33, 34	EF683324	9-143x	EV650801	4-VR1	ZS325495	9-15x		
EC427228	1-C60, 61	EI650362	1-IC1	EW374894	9-48x	ZS325495	9-52x		
EC427228	1-C63	EI650586	1-IC2	EW516600	9-49x	ZS325495	10-11x		
EC428995	8-C2	EI650597	1-IC3	EZ246936	9-45x	ZS406416	9-87x		
EC433697	1-C11	EJ205986	9-146x	EZ602403	3-7	ZS421740	9-26x		
EC450055	1-C32	EJ254957	9-132x	EZ610773	9-107x	ZS421806	3-8		
EC450055	1-C51	EJ299316	9-32	EZ624734	9-9x	ZS422076	1-5		
EC450055	1-C58	EJ514822	7-3	EZ626141	9-2x	ZS422076	6-3		
EC450055	5-C4	EJ539447	9-133x	EZ626152	9-1	ZS422076	9-84x		
EC450527	1-C29	EJ539447	9-65x	EZ646626	9-118x	ZS422965	9-10x		
EC450527	4-C5, 6	EJ539662	1-6	EZ650913	3-6	ZS432674	9-96x		

AA-1030

R	OTHER	CRK	CSA
R1	1.5K(2)	1/2W 1.5K(2)	
R2	1.5K(2)	1/2W 1.5K(2)	

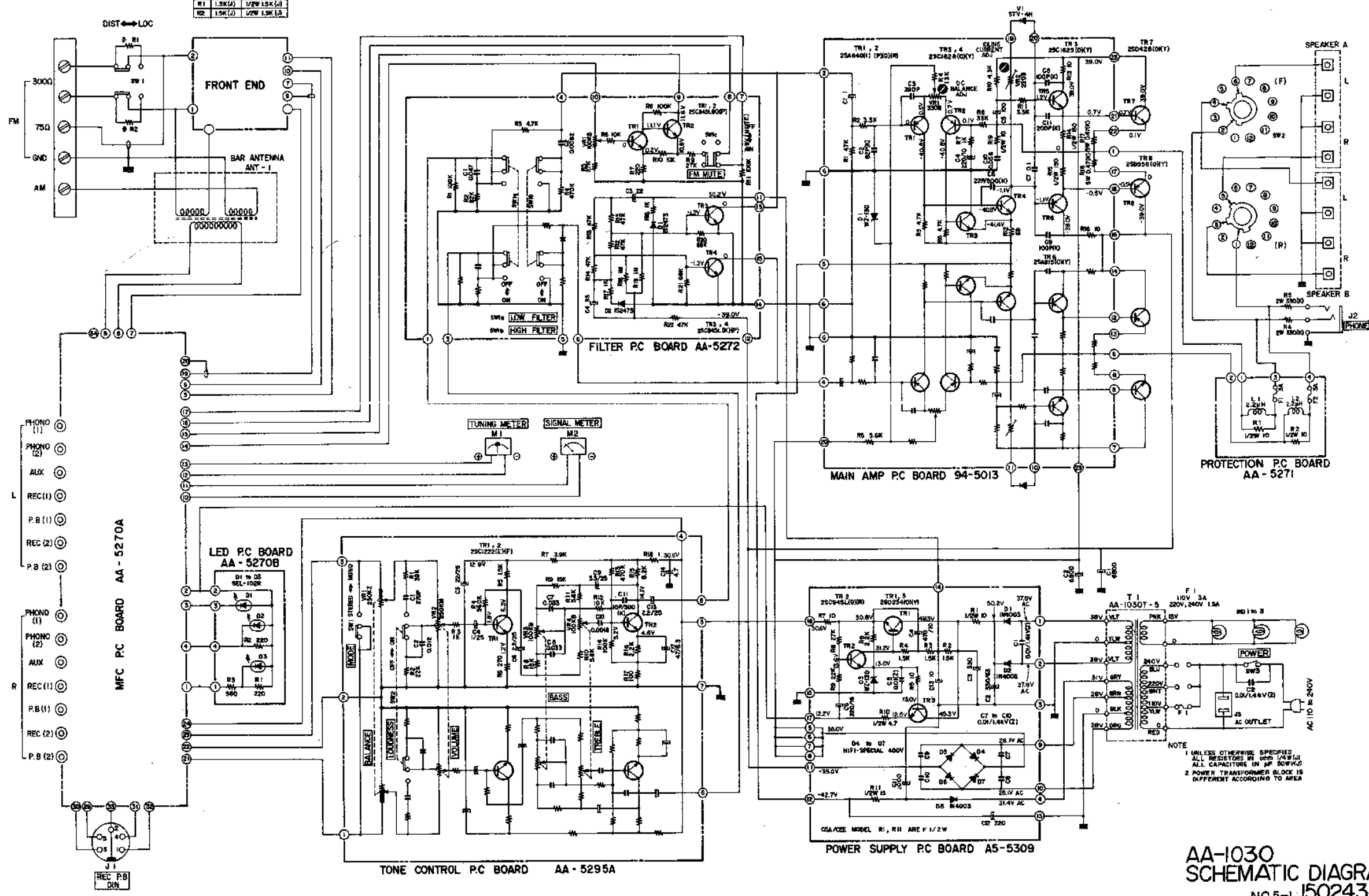

AA-1030  
SCHEMATIC DIAGRAM  
NO.5-1 1502434B

AA-1030L

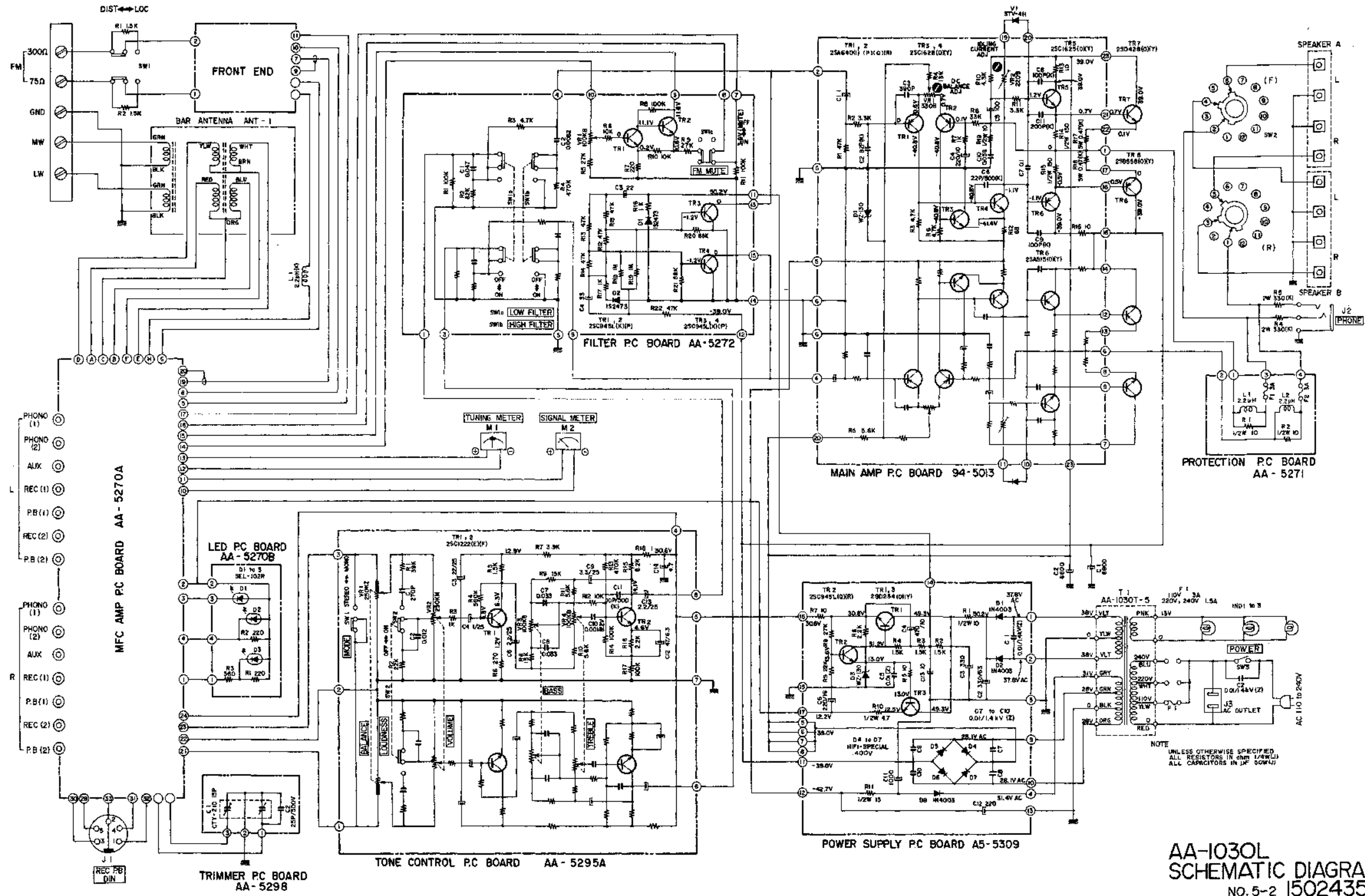

AA-1030L  
SCHEMATIC DIAGRAM  
NO. 5-2 1502435B  
2c

AA-1030

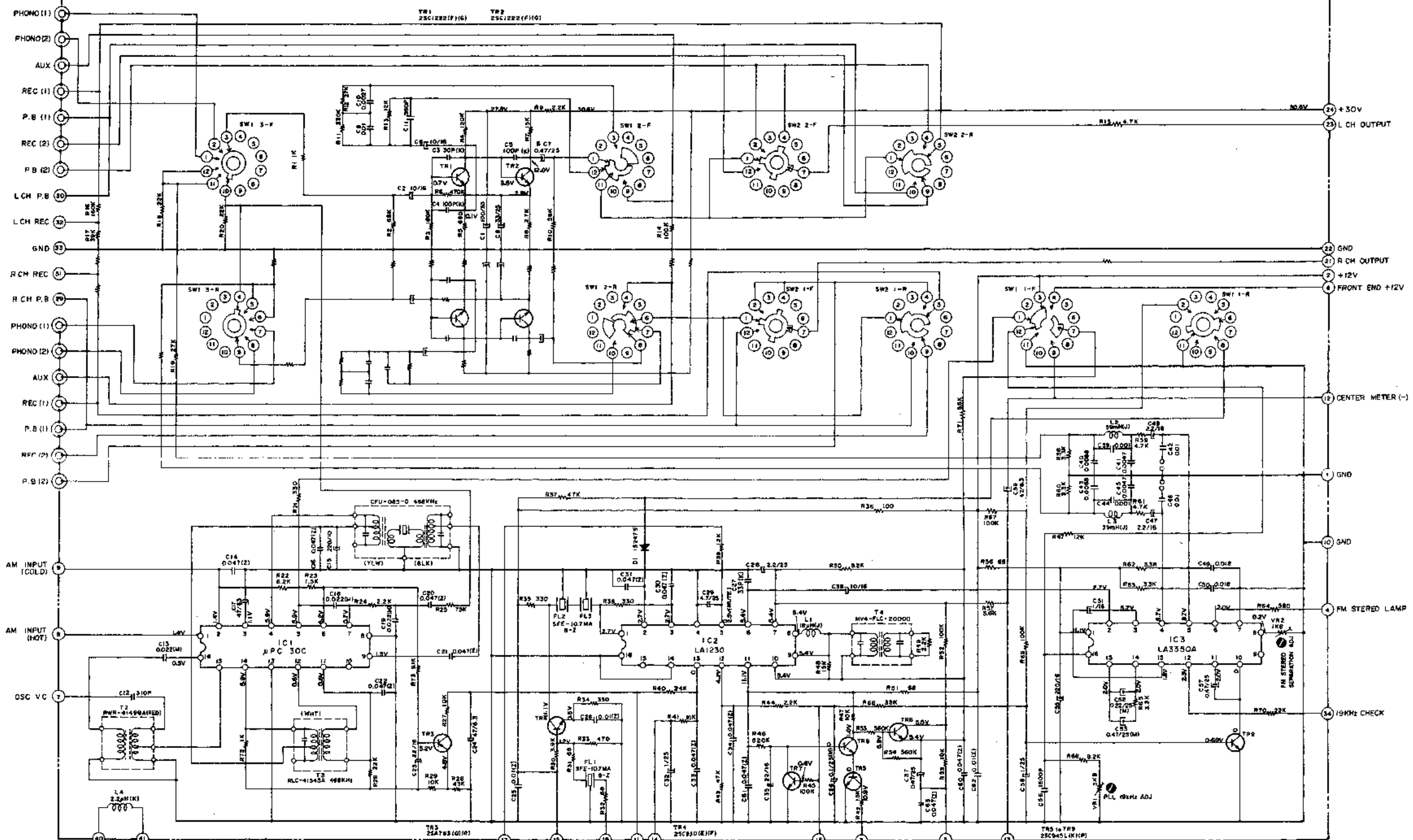

MFC PC BOARD AA-5270A

NOTE  
 1 UNLESS OTHERWISE SPECIFIED  
 ALL RESISTORS IN OHMS (Ω)  
 ALL CAPACITORS IN μF (μF)  
 2 \* MARK INDICATES LOW LEAKAGE CAPACITORS  
 3 CAPACITORS C62, C46 ARE CONNECTED AT 75 μsec  
 (FM DE-EMPHASIS TIME CONSTANT)

AA-1030  
 SCHEMATIC DIAGRAM  
 NO. 5-3 1502436A

AA-1030L

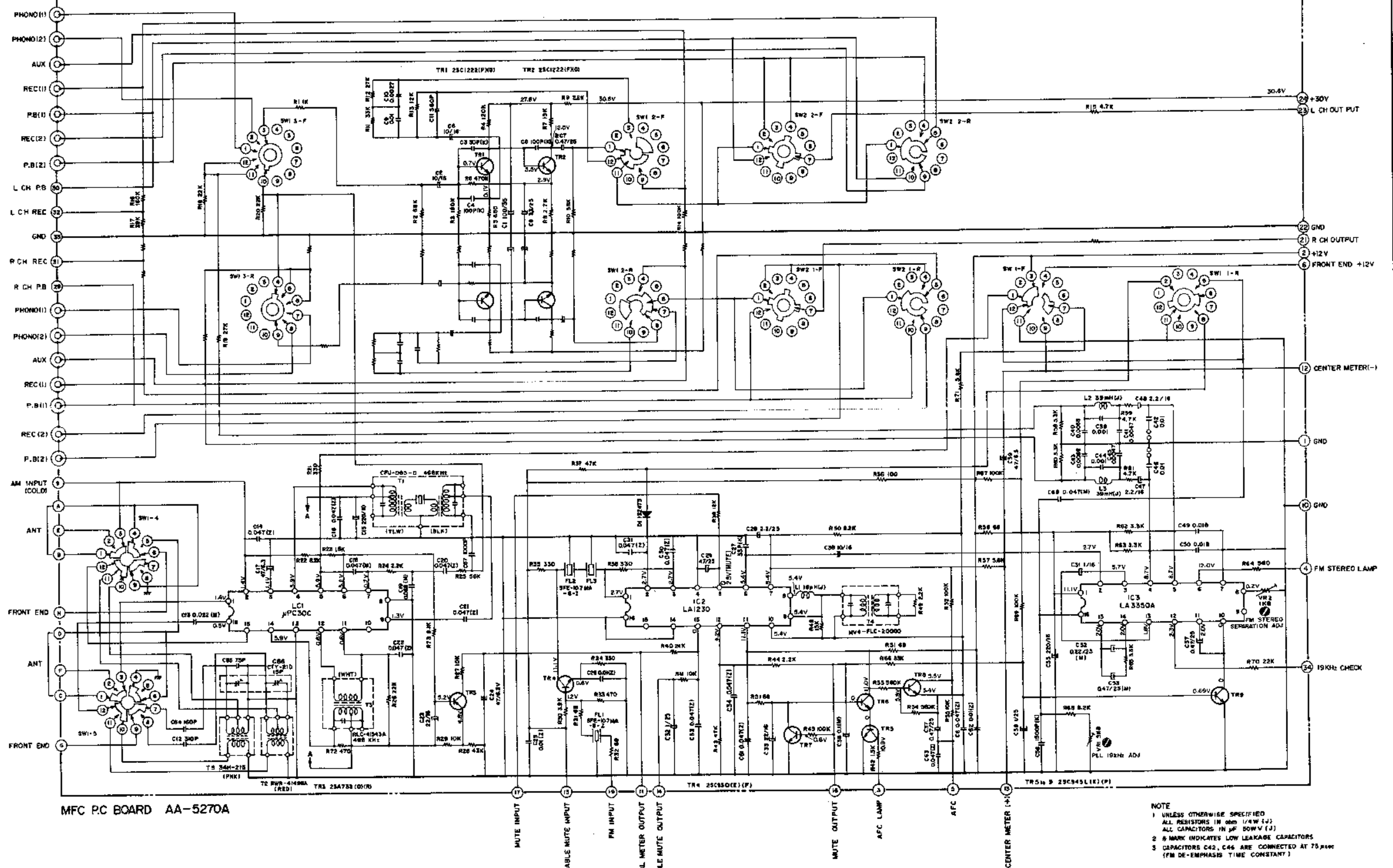

MFC P.C BOARD AA-5270A

NOTE  
 1 UNLESS OTHERWISE SPECIFIED  
 ALL RESISTORS IN OHMS (Ω) UNLESS OTHERWISE SPECIFIED  
 ALL CAPACITORS IN μF UNLESS OTHERWISE SPECIFIED  
 2 \* MARK INDICATES LOW LEAKAGE CAPACITORS  
 3 CAPACITORS C42, C46 ARE CONNECTED AT 75 μsec  
 (FM DE-EMPHASIS TIME CONSTANT)

AA-1030L  
 SCHEMATIC DIAGRAM  
 NO. 5-4 1502437A

AA-1030

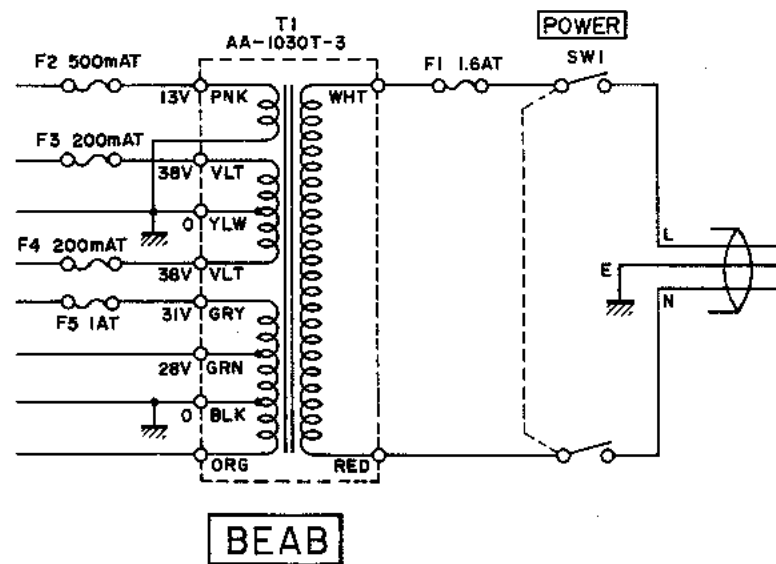
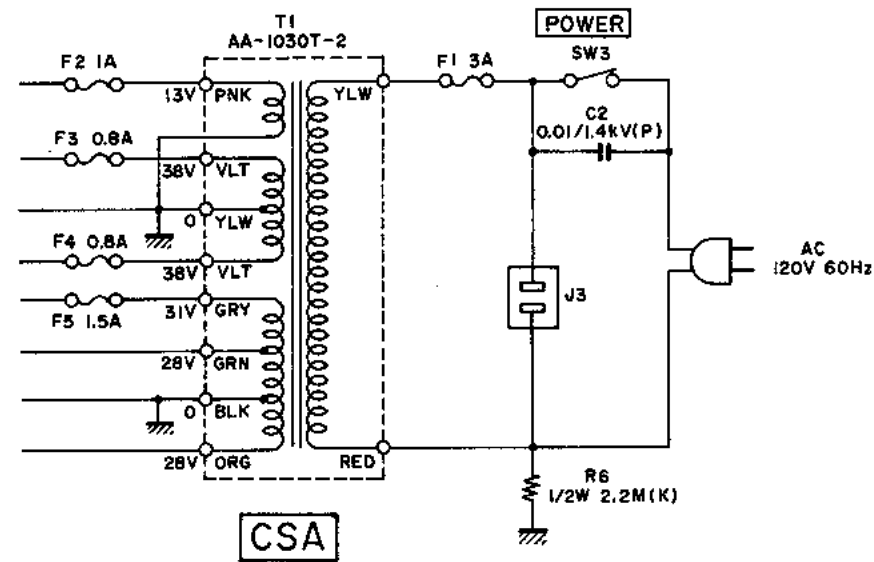
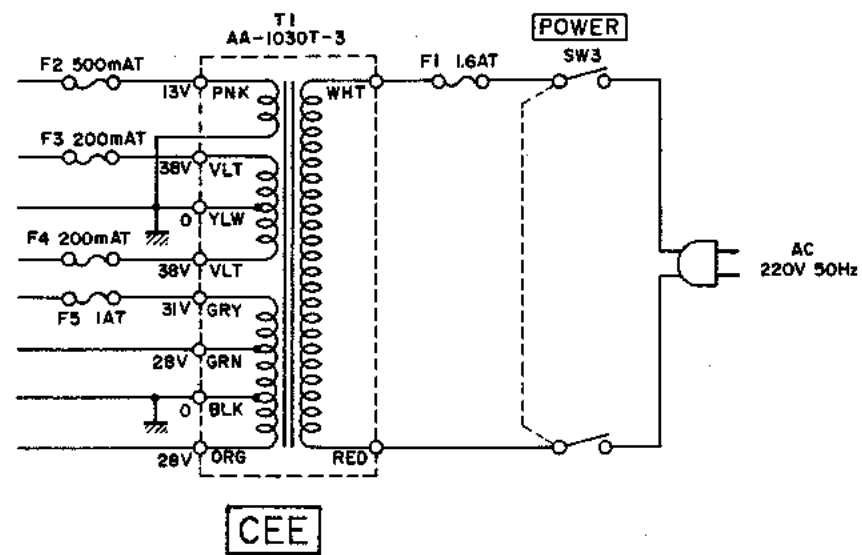

NOTE  
POWER TRANSFORMER BLOCK IS  
DIFFERENT ACCORDING TO AREA

AA-1030  
SCHEMATIC DIAGRAM  
No. 5-5 1502438A